

Part of **Easy** series

Easy TeSys

Catalog



<https://www.se.com>

Life Is On

Schneider
Electric



A trusted partner of Schneider Electric

90 years of leadership in motor starter technology

Easy TeSys provides you **Essential** control & protection for your applications:



HVAC



Compressor



Pumps



Heating/
Furnace

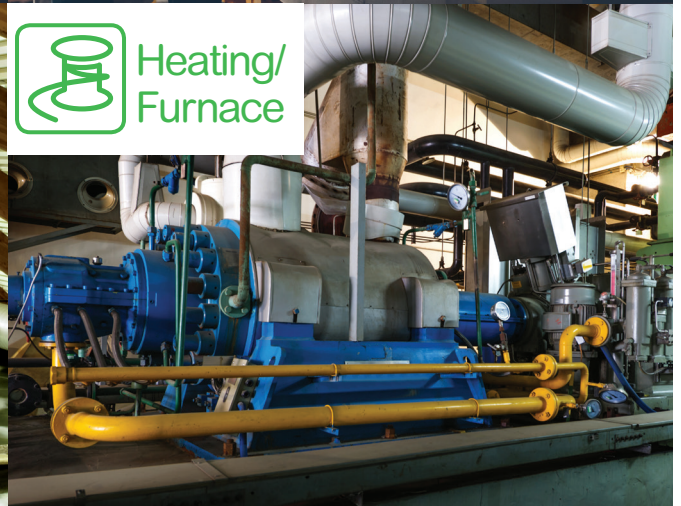

Material
Handling



Packaging



> Easy choice for
simple applications

Easy TeSys



Control motor and other loads

> Easy TeSys™ contactors
9A to 32A

Characteristics ▶ A-2

Accessories, spare parts ▶ A-9

Dimensions, mounting ▶ A-10



Protect your load
(direct mounting under contactors)

> Easy TeSys™ thermal
overload relays up to
32A

Characteristics ▶ B-2

Dimensions, mounting ▶ B-4



Standalone & group applications

> Easy TeSys™ Manual
motor starters up to
32A

Presentation ▶ C-1

References ▶ C-1

Characteristics ▶ C-3

Dimensions, mounting ▶ C-5

Presentation

An easy solution for OEM's, panel builders, contractors and system integrators who have a need for motor control, resistive load switching, and isolation applications. For use on conveyors, packaging, pumps, compressors, HVAC, refrigeration, furnace applications, and more!

Easy TeSys contactors are ideal for these types of applications with power ratings and an operational life of approximately 1 million electrical operations.

UL/CSA approved rated up to 32 amps, 20 HP/480VAC and 25 HP/600VAC.

They are suitable for the utilisation categories specified in standard IEC 60947:

- **AC-1:** non inductive loads or slightly inductive loads, resistance furnaces
- **AC-3:** squirrel cage motors. Motor starting and breaking whilst running.
Example: standard squirrel cage motors, pumps and fans.
- **AC-4:** squirrel cage or slip ring motors. Applications with reverse current braking and inching.
- **AC-8a:** control of sealed refrigeration compressor motors with manual reset of overload trips.
- **AC-8b:** control of sealed refrigeration compressor motors with automatic reset of overload trips.



DPE 09●●



DPE 38●●

3-pole Contactors for Connection by Screw Clamp Terminals

Utilisation category AC-3							Rated Operational Current 440 V up to 690 V	Instantaneous Auxiliary Contact	Basic Reference To be Completed by Adding the Voltage Code (1)	Weight
Standard Power Ratings of 3-phase Motors 50/60 Hz ($\theta \leq 60^\circ\text{C}$)										
220 V	380 V	415 V	440 V	500 V	660 V	690 V				
230 V 400 V										
kW	kW	kW	kW	kW	kW	A			Lb	
2.2	4	4	4	5.5	5.5	9	1	DPE 09●●	0.705 (0.320kg)	
3	5.5	5.5	5.5	7.5	7.5	12	1	DPE 12●●	0.717 (0.325kg)	
4	7.5	9	9	10	10	18	1	DPE 18●●	0.728 (0.330kg)	
5.5	11	11	11	15	15	25	1	DPE 25●●	0.816 (0.370kg)	
7.5	15	15	15	18.5	18.5	32	1	DPE 32●●	0.827 (0.375kg)	
9	18.5	18.5	18.5	18.5	18.5	38	1	DPE 38●●	0.838 (0.380kg)	

3-pole Contactors Conforming to UL and CSA Standards (North American Market)

Standard Power Ratings of Motors 50/60 Hz $\theta < 140^\circ\text{F}$ (60°C)							Associated Cable Type 75°C-Cu	Continuous Current	Basic Reference To be Completed by Adding the Voltage Code (1)	Weight
Single-phase 3-phase 3 Ø										
115V	230V	200V	230V	460V	575V	75V				
240V 208V 240V 480V 600V										
HP	HP	HP	HP	HP	HP	AWG	A			Lb
1/3	1	2	2	3	7.5	18...10	20	DPE 09●●	0.705 (0.320kg)	
1/3	1	2	2	5	7.5	18...10	25	DPE 12●●	0.717 (0.325kg)	
1/2	2	3	3	7.5	10	18...10	25	DPE 18●●	0.728 (0.330kg)	
1	3	5	5	10	15	18...8	32	DPE 25●●	0.816 (0.370kg)	
2	3	7.5	7.5	15	20	14...6	40	DPE 32●●	0.827 (0.375kg)	
2	5	10	10	20	25	14...6	52	DPE 38●●	0.838 (0.380kg)	

Utilisation Category AC-1

Non Inductive Loads Maximum Current ($\theta \leq 60^\circ\text{C}$)		Instantaneous Auxiliary Contact	Basic Reference To be Completed by Adding the Voltage Code (1)	Weight
A		Lb		
20		1	DPE 09●●	0.705 (0.320kg)
25		1	DPE 12●●	0.717 (0.325kg)
32		1	DPE 18●●	0.728 (0.330kg)
40		1	DPE 25●●	0.816 (0.370kg)
50		1	DPE 32●●	0.827 (0.375kg)
			or DPE 38●●	0.838 (0.380kg)

(1) Standard control circuit voltages:

a.c. Supply			
Volts	24	120	240
50/60 Hz	B7	G7	U7

d.c. Supply	
Volts	24
	BL ⁽¹⁾

(1) Built-in suppression device, by bi-directional peak limiting diode.

Environment Characteristics				
Contactor Type			DPE 09...25	DPE 32...38
Rated insulation voltage (Ui)	Conforming to IEC 60947-4-1, overvoltage category III, degree of pollution: 3	V	690	
	Conforming to UL, CSA	V	600	
Rated impulse withstand voltage (Uimp)	Conforming to IEC 60947	kV	6	
Conforming to standards			IEC/EN 60947-4-1, UL 60947-4-1, CSA C22.2 No. 60947-4-1	
Product certifications			UL, CSA	
Isolation	Conforming to VDE 0106 part 101 and A1 (draft 2/89)	V	400	
Degree of protection (1) (front face only) Conforming to VDE 0106	Power connection		Protection against direct finger contact IP 2X	
	Coil connection		Protection against direct finger contact IP 2X	
Protective treatment	Conforming to IEC 60068		"TH"	
Ambient air temperature around the device	Storage	°F	-76...176 (-60...80°C)	
	Operation	°F	23...140 (-5...60°C)	
	Permissible	°F	-40...158 (-40...70°C), for operation at U _c	
Maximum operating altitude	Without derating	ft	6561.68 (2000m)	
Operating positions	Without derating		± 30° occasional, in relation to normal vertical mounting plane	
Flame resistance	Conforming to UL 94		V1	
	Conforming to IEC 60695-2-1	°F	1760 (960°C)	
Shock resistance (2) 1/2 sine wave = 11 ms	Contacteur open		8 gn	6.4 gn
	Contacteur closed		12 gn	12 gn
Vibration resistance (2) 5...300 Hz	Contacteur open		1.6 gn	1.6 gn
	Contacteur closed		3.2 gn	3.2 gn

Power Circuit Connection Characteristics						
Connection by Cable						
Contactor Type			DPE 09...18	DPE 25	DPE 32	DPE 38
Tightening torque			Screw terminals			
Flexible cable without cable end	1 conductor	mm ²	1...4	1.5...6	1.5...10	2.5...10
	2 conductors	mm ²	1...4	1.5...6	1.5...6	2.5...10
Flexible cable with cable end	1 conductor	mm ²	1...4	1...6	1...6	1...10
	2 conductors	mm ²	1...2.5	1...4	1...4	1.5...6
Solid cable without cable end	1 conductor	mm ²	1...4	1.5...6	1.5...6	1.5...10
	2 conductors	mm ²	1...4	1.5...6	1.5...6	2.5...10
Screwdriver	Philips		N°2	N°2	N°2	N°2
	Flat screwdriver Ø		Ø 6	Ø 6	Ø 6	Ø 6
Tightening torque		Lbf.in	15.05 (1.7 N.m)	15.05 (1.7 N.m)	15.05 (1.7 N.m)	15.05 (1.7 N.m)
AWG			10...18	8...18	6...14	6...14

(1) Protection provided for the cabling c.s.a.'s indicated below and for connection by cable.

(2) Without modifying the contact states, in the most unfavourable direction (coil energised at U_e).

Control Circuit Connection Characteristics

Connection by Cable (Screw Clamp Connections)

Contactor Type			DPE 09...18	DPE 25	DPE 32	DPE 38
Flexible cable without cable end	1 conductor	mm ²	1...4	1...4	1...4	1...4
	2 conductors	mm ²	1...4	1...4	1...4	1...4
Flexible cable with cable end	1 conductor	mm ²	1...4	1...4	1...4	1...4
	2 conductors	mm ²	1...2.5	1...2.5	1...2.5	1...2.5
Solid cable without cable end	1 conductor	mm ²	1...4	1...4	1...4	1...4
	2 conductors	mm ²	1...4	1...4	1...4	1...4
Screwdriver	Philips		N°2	N°2	N°2	N°2
	Flat screwdriver Ø		Ø 6	Ø 6	Ø 6	Ø 6
Tightening torque		N.m	1.7	1.7	2.5	2.5
AWG			10...18	10...18	10...18	10...18

Pole Characteristics

Contactor Type			DPE 09	DPE 12	DPE 18	DPE 25	DPE 32	DPE 38
Rated operational current (Ie) (Ue ≤ 440 V)	In AC-3, θ ≤ 140°F (60°C)	A	9	12	18	25	32	38
	In AC-1, θ ≤ 140°F (60°C)	A	20	25	32	40	50	50
Electrical durability at rated operational current	@600V		1M operations					
Rated operational voltage (Ue)	Up to	V	690	690	690	690	690	690
Frequency limits	Of the operating current	Hz	25...400	25...400	25...400	25...400	25...400	25...400
Conventional thermal current (Ith)	θ 140°F (60°C)	A	25	25	32	40	50	50
Rated making capacity (440 V)	Conforming to IEC 60947		250	250	300	450	550	550
Rated breaking capacity (440 V)	Conforming to IEC 60947		250	250	300	450	550	550
Permissible short time rating No current flowing for preceding 15 minutes with θ ≤ 104°F (40°C)	For 1 s	A	210	210	240	380	430	430
	For 10 s	A	105	105	145	240	260	310
	For 1 min	A	61	61	84	120	138	150
	For 10 min	A	30	30	40	50	60	60
Protection by fuses Short-circuit protection (U ≤ 690 V)	Without thermal Type 1 overload relay,	A	25	40	50	63	63	63
	Type 2 gG fuse	A	20	25	35	40	63	63
Average impedance per pole	At Ith and 50 Hz	mΩ	2.5	2.5	2.5	2	2	2
Power dissipated per pole for the above operational currents	AC-3	W	0.20	0.36	0.8	1.25	2	3
	AC-1	W	1.56	1.56	2.5	3.2	5	5

Applications with High-Fault Short-Circuit Current ratings

High fault short-circuit current rating with fuses

Cat. Nos.	Max Current	Max Voltage	Maximum Class J Fuse Size
DPE09	100 kA	600 Vac	25 A
DPE12	100 kA	600 Vac	25 A
DPE18	100 kA	600 Vac	30 A
DPE25	100 kA	600 Vac	40 A
DPE32	100 kA	600 Vac	60 A
DPE38	100 kA	600 Vac	80 A

High fault short-circuit current rating with circuit breakers

Cat. Nos.	Max Current	Max Voltage	Maximum Listed Circuit Breaker Size
DPE09	35 kA	480 Vac	35 A
DPE12	35 kA	480 Vac	35 A
DPE18	35 kA	480 Vac	35 A
DPE25	35 kA	480 Vac	60 A
DPE32	35 kA	480 Vac	60 A
DPE38	35 kA	480 Vac	60 A

High fault short-circuit current rating with circuit breakers

Cat. Nos.	Max Current	Max Voltage	Maximum Listed Circuit Breaker Size
DPE09	18 kA	600 Vac	35 A
DPE12	18 kA	600 Vac	35 A
DPE18	18 kA	600 Vac	35 A
DPE25	18 kA	600 Vac	35 A
DPE32	18 kA	600 Vac	60 A
DPE38	18 kA	600 Vac	60 A

Control Circuit Characteristics, a.c. Supply					
Contactor Type			DPE 09...25	DPE 32 and 38	
Rated voltage of control circuit (Uc)	50/60 Hz	V	24...240	24...240	
Control voltage limits	Coils 50/60 Hz	Operation	0.8...1.1 Uc at 50 Hz and 0.85...1.1 Uc at 60 Hz and at 140°F (60°C)		
		Drop-out	0.3...0.6 Uc at 140°F (60°C)		
Average consumption at 68°F (20°C) and at Uc	~ 50 Hz	Inrush	Cos φ	0.75	0.75
			50/60 Hz coil	VA	70
		Sealed	Cos φ	0.3	0.3
	50/60 Hz coil		VA	7	7
	~ 60 Hz		Inrush	Cos φ	0.75
		50/60 Hz coil		VA	70
Sealed		Cos φ	0.3	0.3	0.3
50/60 Hz coil	VA	7.5	7.5	7.5	
Heat dissipation	50/60 Hz	W	2...3	2...3	
Operating time (1)		Closing "C"	ms	12...22	12...22
		Opening "O"	ms	4...19	4...19
Mechanical durability in millions of operating cycles	50 or 60 Hz coils		-	-	
	50/60 Hz coil at 60 Hz		10	10	
Maximum operating rate at ambient temperature ≤ 140°F (60°C)	In operating cycles per hour		3600	3600	

(1) The closing time "C" is measured from the moment the coil supply is switched on to initial contact of the main poles.

(2) The opening time "O" is measured from the moment the coil supply is switched off to the moment the main poles separate.

Control Circuit Characteristics, d.c. Supply					
Contactor Type			DPE 09...25	DPE 32 and 38	
Rated control circuit voltage (Uc)		V	24	24	
Rated insulation voltage	Conforming to IEC 60947-1	V	690		
	Conforming to UL, CSA	V	600		
Control voltage limits	Operation		0.7 ... 1.25 Uc at 140°F (60°C)		
	Drop-out		0.1 ... 0.25 Uc at 140°F (60°C)		
Average consumption at 68°F (20°C) and at Uc	Inrush	W	5.4	5.4	
	Sealed	W	5.4	5.4	
Operating time	Closing "C"	ms	63±15%	63±15%	
	Opening "O"	ms	63±15%	63±15%	
			Note: The arcing time depends on the circuit switched by the poles. For all normal 3-phase applications, the arcing time is less than 10ms. The load is isolated from the supply after a time equal to the sum of the opening time and the arcing time		
Time constant (L/R)	Closing "C"	ms	28	28	
Mechanical durability at Uc	In millions of operating cycles		30	30	
Maximum operating rate at ambient temperature ≤ 140°F (60°C)	In operating cycles per hour		3600	3600	

Characteristics of Auxiliary Contacts Incorporated in the Contactor

Rated operational voltage (Ue) Up to	V	690
Rated insulation voltage (Ui)	Conforming to IEC 60947-1	V 690
	Conforming to UL, CSA	V 600
Conventional thermal current (Ith)	For ambient temperature ≤ 140°F (60°C)	A 10
Frequency of the operational current	Hz	25...400
Minimum switching capacity λ = 10 ⁻⁸	U min	V 17
	I min	mA 5
Short-circuit protection	Conforming to IEC 60947-5-1	gG fuse: 10 A
Rated making capacity	Conforming to IEC 60947-5-1, I rms	~ : 140, --- : 250
Short-time rating	Permissible for 1 s	A 100
	500 ms	A 120
	100 ms	A 140
Insulation resistance	MΩ	> 10

Rated Operational Power of Auxiliary Contacts (Conforming to IEC 60947-5-1)

a.c. Supply, Categories AC-14 and AC-15

Electrical durability (valid for up to 3600 operating cycles/hour) on an inductive load such as the coil of an electromagnet: making power (cos φ 0.7) = 10 times the power broken (cos φ 0.4).

	V	24	48	115	230	400	440	600
1 million operating cycles	VA	60	120	280	560	960	1050	1440
3 million operating cycles	VA	16	32	80	160	280	300	420
10 million operating cycles	VA	4	8	20	40	70	80	100

d.c. Supply, Category DC-13

Electrical durability (valid for up to 1200 operating cycles/hour) on an inductive load such as the coil of an electromagnet, without economy resistor, the time constant increasing with the power.

	V	24	48	125	250	440
1 million operating cycles	VA	96	76	76	76	44
3 million operating cycles	VA	48	38	38	32	-
10 million operating cycles	VA	14	12	12	-	-

AC-15

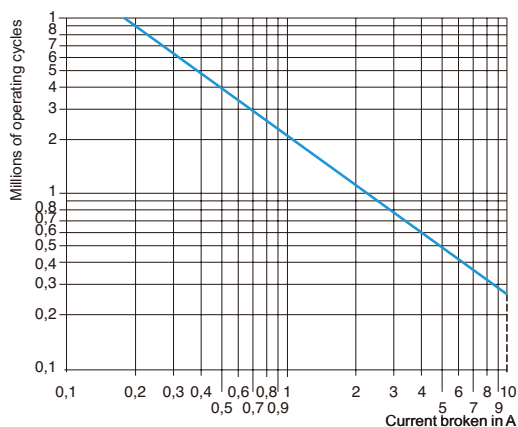

DC-13

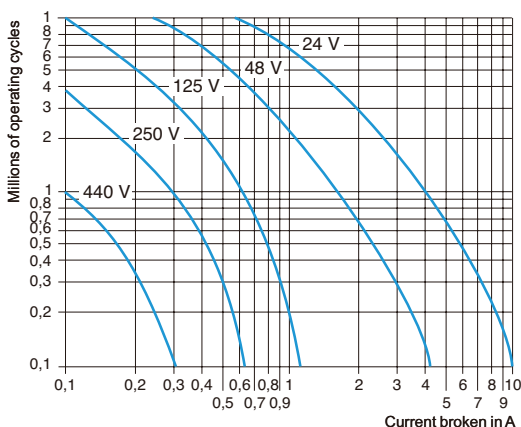

Environment Characteristics			
For Use in Normal Operating Environments			
Type of Contact Block		DPEAN	
Conforming to standards		IEC 60947-5-1, NF C 63-140, EN 60947-5-1, UL 60947-5-1 and CSA C22.2 No.60947-5-1	
Product certifications		UL, CSA	
Protective treatment	Conforming to IEC 60068	"TH"	
Degree of protection	Conforming to VDE 0106	Protection against direct finger contact IP 2X	
Ambient air temperature around the device	Storage	°F	-76...176 (-60...80°C)
	Operation	°F	23...140 (-5...60°C)
	Permissible for operation at U _c	°F	-40...158 (-40...70°C)
Maximum operating altitude	Without derating	ft	6561.68 (2000m)
Connection by cable	Philips n°2 and Ø 0.236 (6mm)	mm ²	Min: 1 x 1, max: 2 x 2.5
	Flexible or rigid cable with or without cable end		
Characteristics of Instantaneous Contacts			
Type of Contact Block		DPEAN	
Number of contacts		2	
Rated operational voltage (U _e) Up to		V	690
Rated insulation voltage (U _i)	Conforming to IEC 60947-5-1	V	690
	Conforming to UL, CSA	V	600
Conventional thermal current (I _{th})	For ambient temperature ≤ 140°F (60°C)	A	10
Frequency of the operational current		Hz	25...400
Minimum switching capacity	U min	V	17
	I min	mA	5
Short-circuit protection	Conforming to IEC 60947-5-1 and VDE 0660	gG	fuse: 10 A
Rated making capacity	Conforming to IEC 60947-5-1, I rms	A	a : 140, c : 250
Short-time rating	Permissible for	1 s	A 100
		500 ms	A 120
		100 ms	A 140
Insulation resistance		mΩ	> 10
Mechanical durability	In millions of operating cycles		30

Use in Category AC-1 ($U_e \leq 440\text{ V}$)

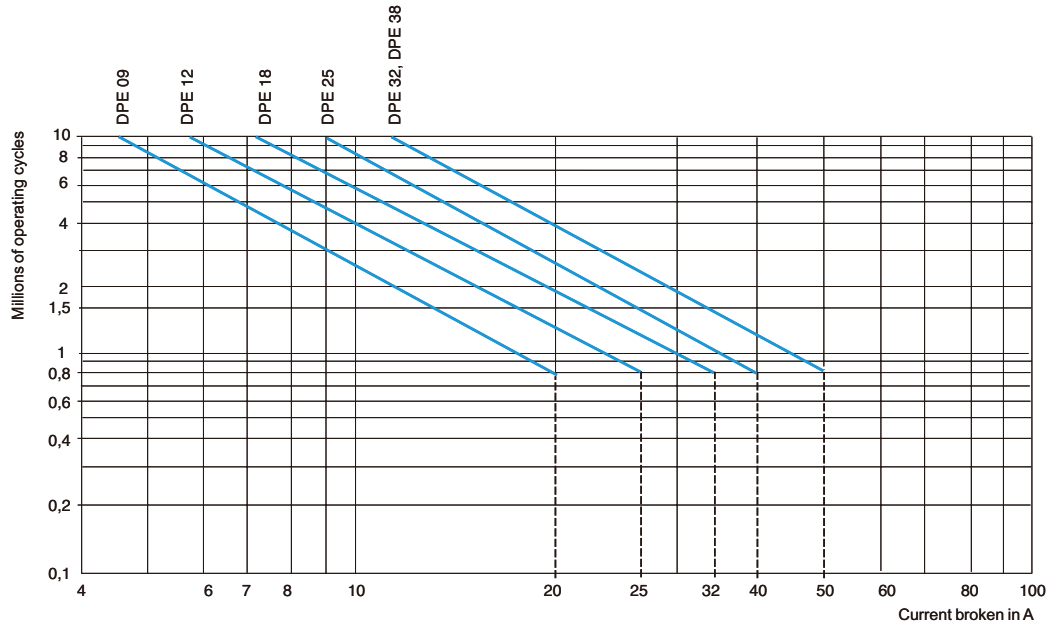

Control of resistive circuits ($\cos \varphi \geq 0.95$).

The current broken (I_c) in category AC-1 is equal to the current (I_e) normally drawn by the load.

Example:

$U_e = 400\text{ V} - I_e = 25\text{ A} - \theta \leq 104^\circ\text{F} (40^\circ\text{C}) - I_c = 25\text{ A}$

1.5 million operating cycles required

The above selection curves show the contactor rating needed: DPE 25

Use in Category AC-3 ($U_e \leq 440\text{ V}$)

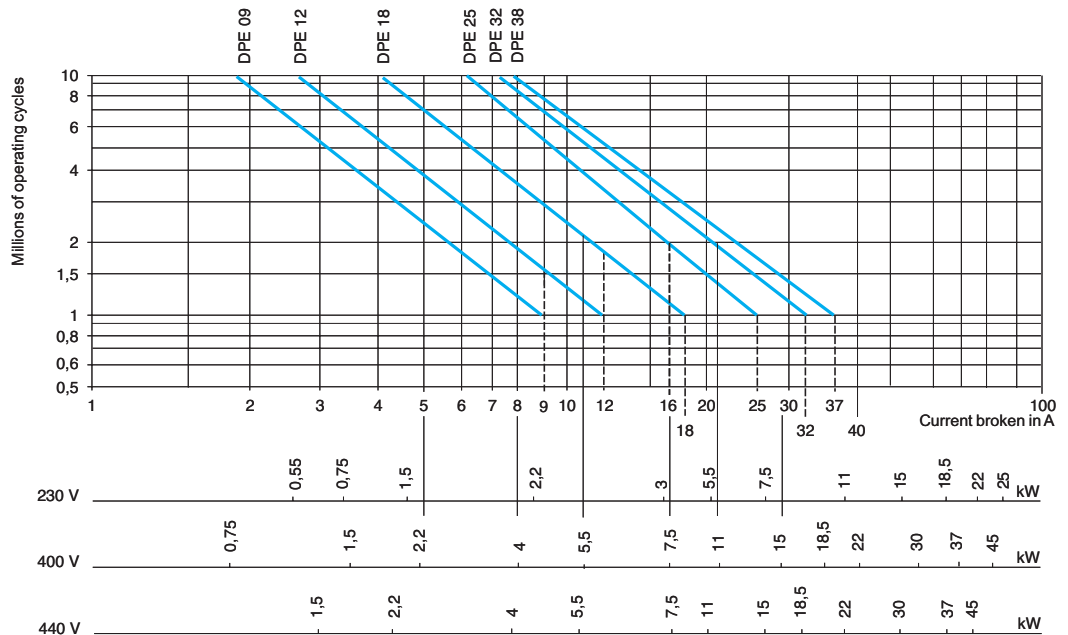

Control of 3-phase asynchronous squirrel cage motors with breaking whilst running. The current broken (I_c) in category AC-3 is equal to the rated operational current of the motor.

Example:

Asynchronous motor with $P = 5.5\text{ kW} - U_e = 400\text{ V} - I_e = 11\text{ A} - I_c = I_e = 11\text{ A}$

or asynchronous motor with $P = 5.5\text{ kW} - U_e = 415\text{ V} - I_e = 11\text{ A} - I_c = I_e = 11\text{ A}$

2 million operating cycles required

The above selection curves show the contactor rating needed: DPE 18

Use in Category AC-4 ($U_e \leq 440\text{ V}$)

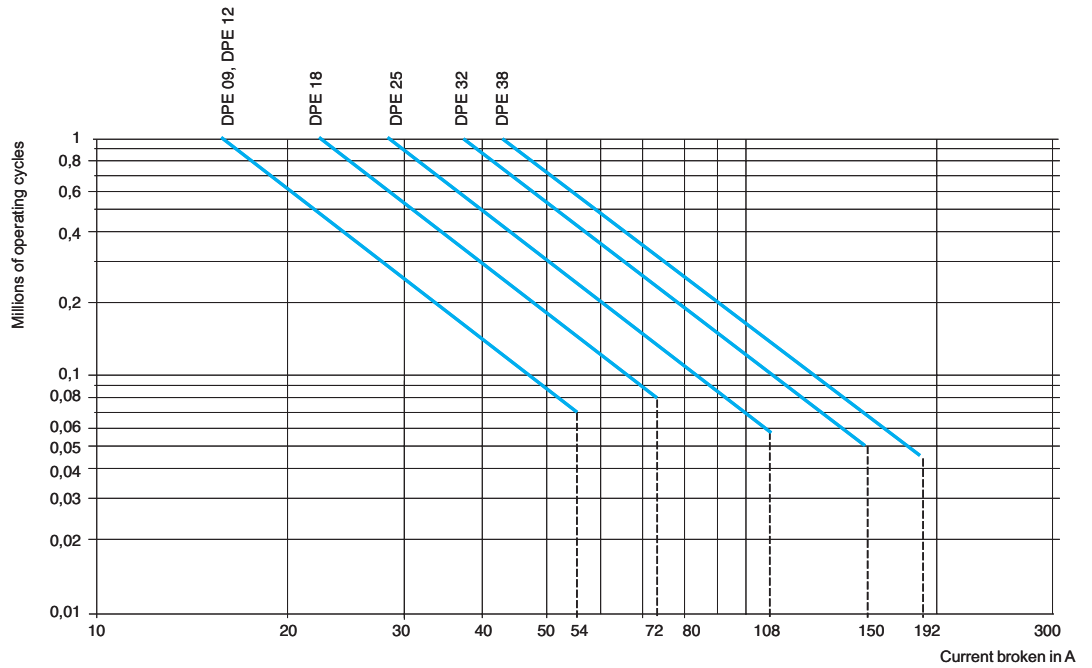

Control of 3-phase asynchronous squirrel cage motors with breaking whilst motor stalled.
The current broken in AC-4 is equal to $6 \times I_e$. (I_e = rated operational current of the motor).

Example:

Asynchronous motor with $P = 5.5\text{ kW}$ - $U_e = 400\text{ V}$ - $I_e = 11\text{ A}$
or asynchronous motor with $P = 5.5\text{ kW}$ - $U_e = 415\text{ V}$ - $I_e = 11\text{ A}$
 $I_c = 6 \times I_e = 66\text{ A}$

300 000 operating cycles required.

The above selection curves show the contactor rating needed: DPE 32

Easy TeSys contactors

Accessories

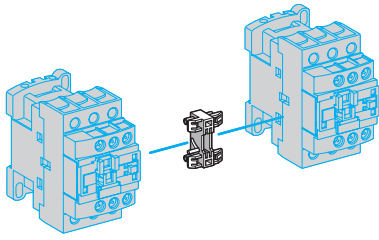

+

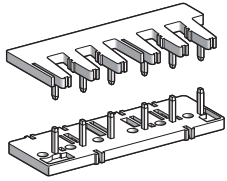

LAD 9R1

For 3-pole Reversing Contactors for Motor Control (1)

Description	Reference	Weight Lb
Kit comprising:	LAD9R1	0.099 (0.045kg)
■ 1 mechanical interlock without electrical interlocking.		
■ 1 set of power connections.		

Instantaneous Auxiliary Contact Blocks for Connection by Screw Clamp Terminals

Description	Number of Contacts per Block	NO	NC	Reference	Weight Lb
Contact blocks (clip-on front mounting)	2	1	1	DPEAN11	0.066 (0.030kg)

(1) Horizontally mounted, assembled by the customer using 2 identical contactors.

Dimensions

DPE 09...25

$\frac{\text{in.}}{\text{mm}}$

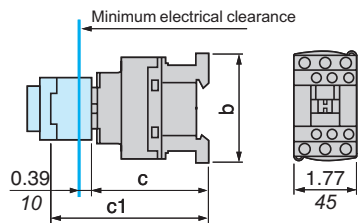

DPE 32 and 38

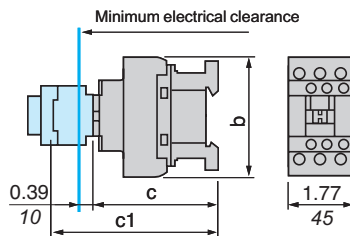

	DPE 09...25
b	3.03 (77mm)
c without add-on block	3.31 (84mm)
c1 with DPEAN (2 contacts)	4.61 (117mm)

	DPE 32 and 38
b without add-on block	3.35 (85mm)
c without add-on block	3.54 (90mm)
c1 with DPEAN (2 contacts)	4.84 (123mm)

Reversing Contactors DPE 09...38

$\frac{\text{in.}}{\text{mm}}$

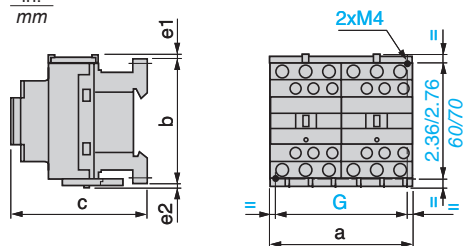

	DPE 09...25	DPE 32 and 38
a	3.54 (90mm)	3.54 (90mm)
b	3.03 (77mm)	3.35 (85mm)
c	3.39 (86mm)	3.62 (92mm)
e1	0.16 (4mm)	0.35 (9mm)
e2	0.06 (1.5mm)	0.20 (5mm)
G	3.15 (80mm)	3.15 (80mm)

Dimensions

DPE 09...25

$\frac{\text{in.}}{\text{mm}}$

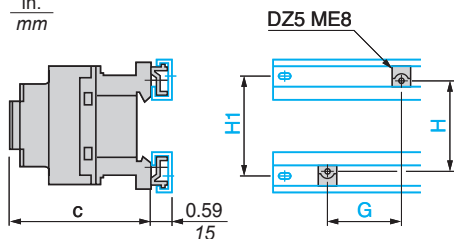

DPE 32 and 38

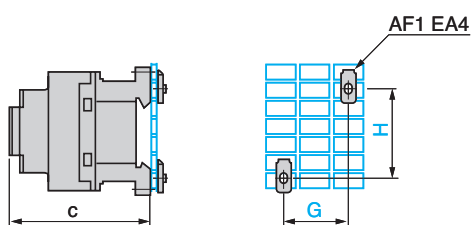

	DPE 09...25	DPE 32 and 38
c	3.39 (86mm)	3.62 (92mm)
G	1.38 (35mm)	1.38 (35mm)
H	2.36 (60mm)	2.36 (60mm)
H1	2.76 (70mm)	2.76 (70mm)

	DPE 09...25	DPE 32 and 38
c	3.39 (86mm)	3.62 (92mm)
G	1.38 (35mm)	1.38 (35mm)
H	2.36 (60mm)	2.36 (60mm)

Mounting

DPE 09...38 on Mounting Rail AM1 DP200, DR 200 or AM1 DE200 (Width 1.38 in./35 mm)

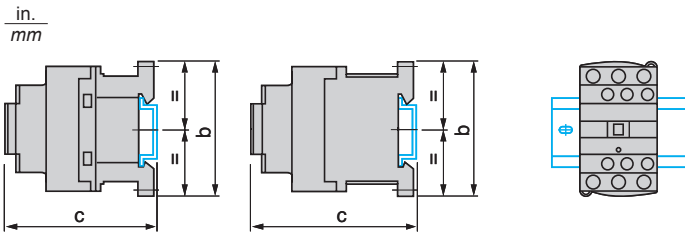

	DPE 09...25	DPE 32 and 38
b	3.03 (77mm)	3.35 (85mm)
c (AM1-DP200 or DR200)	3.46 (88mm)	3.70 (94mm)
c (AM1-DE200)	3.78 (96mm)	4.02 (102mm)

DPE 09...38 Panel Mounted

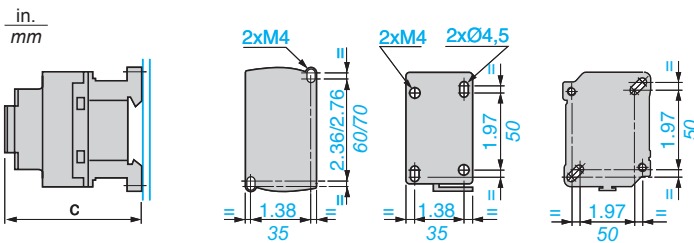

	DPE 09...25	DPE 32 and 38
c	3.39 (86mm)	3.62 (92mm)

Schemes

3-pole Contactors

DPE 09...38

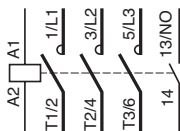

Front Mounted Add-on Contact Blocks. Instantaneous Auxiliary Contacts

1 N/O + 1 N/C

DPEAN11

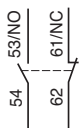



Presentation



Easy TeSys thermal overload relays are designed to protect a.c. circuits and motors against:

- overloads
- phase failure
- long starting time
- prolonged stalled rotor condition.

The thermal relay permanently controls the current driven by the motor. When this current exceeds the setting, its auxiliary contacts will change state, causing the motor to stop.

Description

- 1 Adjustment dial I_r
- 2 Test button
Operation of the Test button allows:
 - checking of control circuit wiring
 - simulation of relay tripping (actuates both the N/O and N/C contacts)
- 3 Stop button. Actuates the N/C contact; does not affect the N/O contact
- 4 Reset button
- 5 Trip indicator
- 6 Setting locked by sealing the cover
- 7 Selector for manual or automatic reset

Easy TeSys overload relays are supplied with the selector in the manual position, protected by a cover.

Deliberate action is required to move it to the automatic position.

Easy TeSys thermal overload relays

3-pole thermal overload relays

Direct connection to Easy TeSys contactors



Differential Thermal Overload Relays

for Use with Fuses or Circuit Breakers

- Compensated relays with manual or automatic reset
- with relay trip indicator
- for a.c

Relay Setting Range (A)	Fuses to Be Used with Selected Relay		For Use with Contactor	Reference	Weight Lb
	aM (A)	gG (A)			
Class 10 ⁽¹⁾ for Connection by Screw Clamp Terminals					
0.10...0.16	0.25	2	DPE09...32	DPER01	0.287 (0.13kg)
0.16...0.25	0.5	2	DPE09...32	DPER02	0.287 (0.13kg)
0.25...0.40	1	2	DPE09...32	DPER03	0.287 (0.13kg)
0.40...0.63	1	2	DPE09...32	DPER04	0.287 (0.13kg)
0.63...1	2	4	DPE09...32	DPER05	0.287 (0.13kg)
1...1.6	2	4	DPE09...32	DPER06	0.287 (0.13kg)
1.6...2.5	4	6	DPE09...32	DPER07	0.287 (0.13kg)
2.5...4	6	10	DPE09...32	DPER08	0.287 (0.13kg)
4...6	8	16	DPE09...32	DPER10	0.287 (0.13kg)
5.5...8	12	20	DPE09...32	DPER12	0.287 (0.13kg)
7...10	12	20	DPE09...32	DPER14	0.287 (0.13kg)
9...13	16	25	DPE12...32	DPER16	0.287 (0.13kg)
12...18	20	35	DPE18...32	DPER21	0.287 (0.13kg)
16...24	25	50	DPE25...32	DPER22	0.287 (0.13kg)
23...32	40	63	DPE25...32	DPER32	0.287 (0.13kg)

⁽¹⁾ Standard UL 60947-4-1 specifies a tripping time for 7.2 times the setting current I_R : class 10: between 4 and 10 seconds.

Power Circuit Characteristics				
Relay Type		Ref.	DPER 01...21	DPER 22...32
		Size	1	
Tripping class	Conforming to IEC 60947-4-1		10	
Rated insulation voltage	Conforming to IEC 60947-4-1	V	690	
Rated impulse withstand voltage (Uimp)		kV	6	
Frequency limits	Of the operating current	Hz	50...60	
Setting range	Depending on model	A	0.1...18	16...38
Power Circuit Connections				
Connection by Screw Clamp Terminals		Minimum/maximum c.s.a.		
	Flexible cable without cable end 1 conductor	mm ²	1.5...6 AWG 16...10	2.5...10 AWG 14...8
	Flexible cable with cable end 1 conductor		1...4 AWG 18...10	1.5...6 AWG 16...10
	Solid cable without cable end 1 conductor		1...6 AWG 18...10	2.5...10 AWG 14...8
	Tightening torque	Lbf.in	15.05 (1.7N.m)	22.13 (2.5N.m)
Auxiliary Contact Characteristics				
Conventional thermal current		A	5	
Max. sealed consumption of the operating coils of controlled contactors (Occasional operating cycles of contact 95-96)	a.c. supply	V	110	120
		A	3.27	3
Protection against short-circuits	By gG, maximum rating or by GB2	A	5	
Connection by screw clamp terminals	Flexible cable without cable end 1 conductor	mm ²	Minimum/maximum c.s.a. 2 x 1...2.5 AWG 2 x 18...10	
	Flexible cable with cable end 1 conductor		2 x 1...2.5 AWG 2 x 18...10	
	Solid cable without cable end 1 conductor		2 x 1...2.5 AWG 2 x 18...10	
	Tightening torque	Lbf.in	15.05 (1.7N.m)	
Environment				
Conforming to standard			IEC 60947-4-1, IEC 60947-5-1, UL 60947-4-1, CSA C22.2 No. 60947-4-1	
Product certifications			cUL, UL Listed	
Degree of protection	Conforming to IEC 60529		IP2X	
Protective treatment	Conforming to IEC 60068		"TH"	
Ambient air temperature	Storage	°F	-76...176 (-60...80°C)	
	Normal operation without derating (IEC 60947-4-1)		-4...140 (-20...+60°C)	
	Minimum/maximum operating temperature (with derating) ⁽¹⁾		-4...158 (-20...70°C)	
Operating positions without derating	In relation to normal vertical mounting plane		Any position	
Flame resistance	Conforming to IEC 60068-2-1	°F	1562 (850°C)	
Shock resistance	Permissive acceleration conforming to IEC 60068-2-7		6 gn - 11 ms	
Vibration resistance	Permissive acceleration conforming to IEC 60068-2-6		3 gn	
Dielectric strength at 50 Hz	Conforming to IEC 60255-5	kV	6	
Surge withstand	Conforming to IEC 60801-5		6	
Operating Characteristics				
Temperature compensation		°F	-4...140 (-20...+60°C)	
Tripping threshold	Conforming to IEC 60947-4-1	A	1.14 ± 0.06 I _r	
Sensitivity to phase failure	Conforming to IEC 60947-4-1		Tripping current 130 % of I _r on two phase, the last one at 0	

(1) Contact your regional sales.

Tripping Curves

Average Operating Time Related to Multiples of The Setting Current

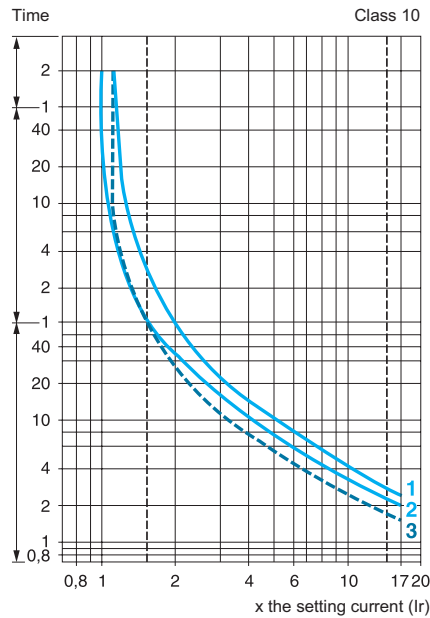

- 1 Balanced operation, 3-phase, without prior current flow (cold state)
- 2 2-phase operation, without prior current flow (cold state)
- 3 Balanced operation, 3-phase, after a long period at the set current (hot state)

DPER01...32

Direct Mounting Under DPE Contactors with Screw Clamp Connections

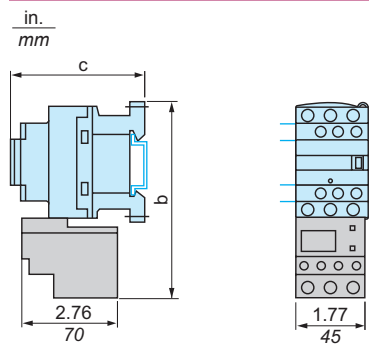

	DPER01...18	DPER25...35
b	4.84 (123mm)	5.39 (137mm)
c	3.39 (86mm)	3.62 (92mm)

Panel Mount Accessory

Description	For Use with	Sold in Lots of	Unit Reference
Terminal block	DPER01...32	1	LAD7B106

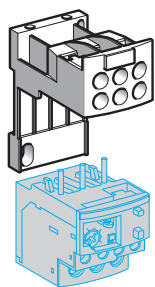

LAD7B106

Protection components

Easy TeSys manual motor controllers

Presentation

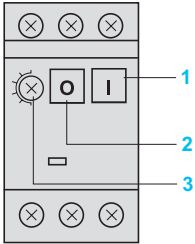

Easy TeSys includes 3-pole thermal-magnetic circuit breakers conforming to IEC 60947-2 and IEC 60947-4-1.

These devices also conform to UL 60947-4-1 as manual motor controllers and are suitable for the motor disconnect.

Easy TeSys manual motor controllers are designed to control and protect motors.

Connection

These circuit breakers are designed for connection by screw clamp terminals. This technique ensures secure, permanent and durable clamping that is resistant to harsh environments, vibration and impact and is even more effective when conductors without cable ends are used. Each connection can take two independent conductors.

Push button control

Energisation is controlled manually by operating the Start button "I" 1. De-energisation is controlled manually by operating the Stop button "O" 2, or automatically by the thermal-magnetic protection elements or by a voltage trip attachment.

Protection of motors

Motor protection is provided by the thermal-magnetic protection elements incorporated in the motor circuit breaker.

As per IEC 60947-4-1 the magnetic elements (short-circuit protection) have a non-adjustable tripping threshold, which is equal to about 13 times the maximum setting current of the thermal trips.

The thermal elements (overload protection) include automatic compensation for ambient temperature variations.

The rated operational current of the motor is displayed by means of a graduated knob 3.

All live parts are protected against direct finger contact.

Easy TeSys manual motor controllers are easily mounted on din rail or directly to the panel.



GP2E

Manual Motor Controllers

Push Button Control

Standard Power Ratings of 3-phase Motors 50/60 Hz in Category AC-3					Setting Range of Thermal Trips	Magnetic Tripping Current Id ± 20 %	Reference	Weight
230 V	400 V	440 V	500 V	690 V				
kW	kW	kW	kW	kW	A	A	Lb	
—	—	—	—	—	0.1...0.16	1.5	GP2E01	0.573 (0.260kg)
—	—	—	—	—	0.16...0.25	2.4	GP2E02	0.573 (0.260kg)
—	—	—	—	—	0.25...0.40	5	GP2E03	0.573 (0.260kg)
—	—	—	—	0.37	0.40...0.63	8	GP2E04	0.573 (0.260kg)
—	—	—	0.37	0.55	0.63...1	13	GP2E05	0.573 (0.260kg)
—	0.37	0.55	0.75	1.1	1...1.6	22.5	GP2E06	0.573 (0.260kg)
0.37	0.75	1.1	1.1	1.5	1.6...2.5	33.5	GP2E07	0.573 (0.260kg)
0.75	1.5	1.5	2.2	3	2.5...4	51	GP2E08	0.573 (0.260kg)
1.1	2.2	3	3.7	4	4...6.3	78	GP2E10	0.573 (0.260kg)
2.2	4	4	5.5	7.5	6...10	138	GP2E14	0.573 (0.260kg)
—	5.5	5.5	9	11	9...14	170	GP2E16	0.573 (0.260kg)
4	7.5	9	10	15	13...18	223	GP2E20	0.573 (0.260kg)
5.5	9	11	11	18.5	17...23	327	GP2E21	0.573 (0.260kg)
5.5	11	11	15	22	20...25	327	GP2E22	0.573 (0.260kg)
7.5	15	15	18.5	22	24...32	416	GP2E32	0.573 (0.260kg)

Manual Motor Controllers from 3/4 to 20HP/460V, with Screw Clamp Terminals

Push Button Control

Thermal Setting (A)	Maximum Horsepower Ratings							Group Motor Applications	Reference	
	Single-Phase			Three-Phase						
	115V	200V	230V	115V	200V	230V	460V	575V		
0.1...0.16	—	—	—	—	—	—	—	—	450	GP2E01
0.16...0.25	—	—	—	—	—	—	—	—	450	GP2E02
0.25...0.40	—	—	—	—	—	—	—	—	450	GP2E03
0.40...0.63	—	—	—	—	—	—	—	—	450	GP2E04
0.63...1	—	—	—	—	—	—	—	1/2	450	GP2E05
1...1.6	—	—	1/10	—	—	—	3/4	3/4	450	GP2E06
1.6...2.5	—	1/6	1/6	—	1/2	1/2	1	1.5	450	GP2E07
2.5...4	1/8	1/4	1/3	—	3/4	3/4	2	3	450	GP2E08
4...6.3	1/4	1/2	1/2	3/4	1	1.5	3	5	450	GP2E10
6...10	1/2	1	1.5	1	2	3	5	7.5	450	GP2E14
9...14	3/4	2	2	2	3	3	10	10	450	GP2E16
13...18	1	2	3	2	5	5	10	15	450	GP2E20
17...23	1.5	3	3	3	5	7.5	15	20	450	GP2E21
20...25	2	—	—	—	7.5	7.5	15	20	450	GP2E22
24...32	2	5	5	5	7.5	10	20	25	450	GP2E32

Protection components

Easy TeSys manual motor controllers

North American Short Circuit and Motor Group Ratings				
Model	Overload Range	Maximum RMS Short-Circuit Current, kA		
		240 V+	480 V+	600 V+
GP2E01	0.1-0.16	35	35	18
GP2E02	0.16-0.25	35	35	18
GP2E03	0.25-0.40	35	35	18
GP2E04	0.40-0.63	35	35	18
GP2E05	0.63-1.0	35	35	18
GP2E06	1.0-1.6	35	35	18
GP2E07	1.6-2.5	35	35	18
GP2E08	2.5-4.0	35	35	18
GP2E10	4.0-6.3	35	35	18
GP2E14	6-10	30	30	18
GP2E16	9-14	25	25	10
GP2E20	13-18	25	25	10
GP2E21	17-23	25	10	10
GP2E22	20-25	25	10	10
GP2E32	24-32	25	10	10

+ - Nominal System Voltage.

Easy TeSys contactors may be used on the load side of the Easy TeSys Manual Motor Controllers in Group Installations on a circuit with an available short-circuit current no greater than shown in the Table below when protected by fuses or circuit breakers:

Type	Contactor DPE	Maximum RMS Short-Circuit Current, kA	
		480 Vac	600 Vac
GP2E01	DPE09 to DPE38	22	22
GP2E02	DPE09 to DPE38	22	22
GP2E03	DPE09 to DPE38	22	22
GP2E04	DPE09 to DPE38	22	22
GP2E05	DPE09 to DPE38	22	22
GP2E06	DPE09 to DPE38	22	22
GP2E07	DPE09 to DPE38	22	22
GP2E08	DPE09 to DPE38	22	22
GP2E10	DPE09 to DPE38	22	22
GP2E14	DPE12 to DPE38	22	22
GP2E16	DPE18 to DPE38	22	10
GP2E20	DPE18 to DPE38	22	10
GP2E21	DPE32 to DPE38	10	10
GP2E22	DPE32 to DPE38	10	10

* The above Group Installations may be used with Schneider's GV2Gx45 or GV2Gx54 busbar, and/or GV1-G09 adapter.

Environment			
Circuit Breaker Type		GP2E	
Conforming to standards		IEC 60947-2, IEC 60947-4-1, UL 60947-4-1, CSA C22.2 No. 60947-4-1	
Product certifications		cUL, UL Listed	
Protective treatment	Conforming to IEC 60068-2-30	IEC60068-2-30 Test Db, Variant 2	
Degree of protection		In GV2 MC01 enclosure: IP 41 In GV2 MC02 enclosure: IP 55	
Ambient air temperature	Storage	°F	-40...176 (-40...80°C)
	Operation		-4...140 (-20...60°C)
Flame resistance	Conforming to IEC 60695-2-1	°F	1760 (960°C)
Maximum operating altitude		ft	6561.68 (2000m)
Cabling		Min.	Max.
Number of conductors and c.s.a.	Solid cable	mm ²	2 x 1 2 x 6
	Flexible cable without cable end	mm ²	2 x 1.5 2 x 6
	Flexible cable with cable end	mm ²	2 x 1 2 x 4
	AWG 75°C CU		8-18
Suitable for isolation	Conforming to IEC 60947-1 § 7-1-6		Yes
Tightening torque		Lbf.in	15.05 (1.7N.m)
Rated operational voltage (Ue)	Conforming to IEC 60947-2	V	690
Rated insulation voltage (Ui)	Conforming to IEC 60947-2	V	690
Rated operational frequency	Conforming to IEC 60947-2	Hz	50/60
Rated impulse withstand voltage (U imp)	Conforming to IEC 60947-2	kV	6
Total power dissipated per pole		W	2.5
Mechanical durability (C.O.: closing, opening)		C.O.	100 000
Electrical durability	For AC-3 duty	C.O.	100 000
Duty class (maximum operating rate)		C.O./h	25

Breaking Capacity											
Circuit Breaker Type		GP2E									
		A	01 to 06	07	08	10	14	16	20	21	22 to 32
Rating		kA	0.1 to 1.6	2,5	4	6.3	10	14	18	23	25 to 32
Breaking capacity	230/240 V	Icu	★	★	★	★	★	★	★	30	30
	conforming to IEC 60947-2	Ics % ⁽¹⁾	★	★	★	★	★	★	★	100	100
400/415 V	Icu	kA	★	★	★	★	★	10	10	10	10
	Ics % ⁽¹⁾		★	★	★	★	★	50	50	40	40
440 V	Icu	kA	★	★	★	30	10	6	6	5	5
	Ics % ⁽¹⁾		★	★	★	100	100	50	50	50	50
500 V	Icu	kA	★	★	★	30	8	5	5	3	3
	Ics % ⁽¹⁾		★	★	★	100	100	75	75	75	75
690 V	Icu	kA	★	2	2	2	2	2	2	2	2
	Ics % ⁽¹⁾		★	75	75	75	75	75	75	75	75

★ > 100 kA
(1) As % of Icu

Tripping Curves

Average Operating Times at 20 °C Related to Multiples of the Setting Current

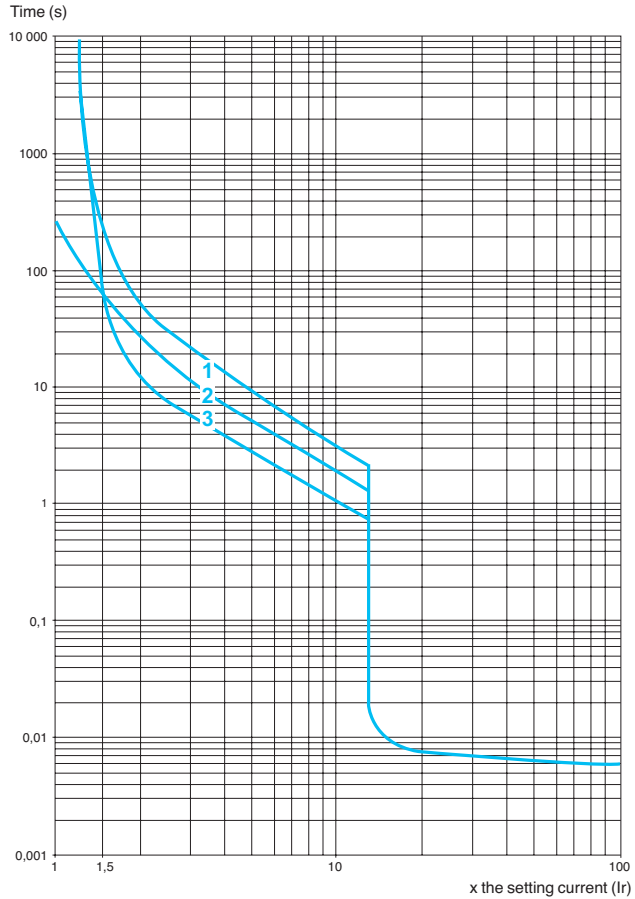

- 1 3 poles from cold state
- 2 2 poles from cold state
- 3 3 poles from hot state

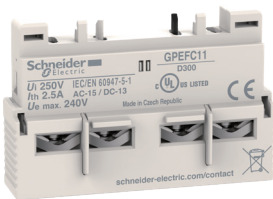

GPEFC11

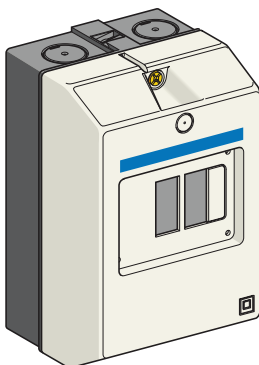

GV2MC

Contact Blocks

Instantaneous Auxiliary Contacts

Mounting	Maximum Number	Type of Contacts	Unit Reference	Weight Lb	Tightening Torque
Side	2	N/O + N/C	GPEFC11	0.11 (0.050kg)	1.2

Enclosures

Type	Degree of Protection	Reference	Weight Lb
Surface mounting, double insulated, with protective sealable cover	IP41	GV2MC01	0.639 (0.290kg)
	IP55	GV2MC02	0.639 (0.290kg)

Wiring Accessories

Description	Application	Pitch in.	Unit Reference
Sets of 3-pole 63A busbars	2 tap-offs	1.77 (45mm)	GV2G245
	3 tap-offs	1.77 (45mm)	GV2G345
	4 tap-offs	1.77 (45mm)	GV2G445
Description	Application	Sold in Lots of	Unit Reference
Terminal Block	Connection from the top	1	GV1G09
Combination Block	Between GP2E and contactor DPE09 to DPE38	10	GV2AF3

Dimensions

GP2E

$\frac{\text{in.}}{\text{mm}}$

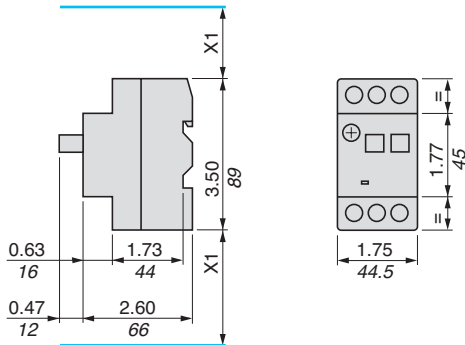

X1: electrical clearance = 1.73 (40mm) for $U_e \leq 690$ V

Mounting

GP2E on 1.38 (35mm) ≤ rail

$\frac{\text{in.}}{\text{mm}}$

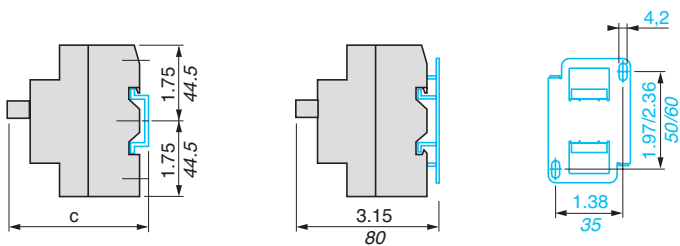

$c = 3.09$ (78.5mm) on AM1 DP200 (35 x 7.5)
 $c = 3.39$ (86mm) on AM1 DE200 and AM1 ED200 (35 x 15)

GV2AF3, Combination GP2E + DPE Contactor

$\frac{\text{in.}}{\text{mm}}$

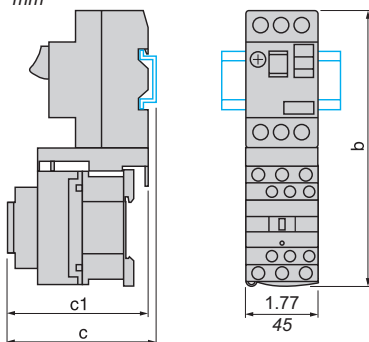

GP2E +	DPE09...D18	DPE25 and D32
b	6.94 (176.4mm)	7.35 (186.8mm)
c1	3.70 (94.1mm)	3.95 (100.4mm)
c	3.92 (99.6mm)	4.17 (105.9mm)

Dimensions

Surface Mounting Enclosure GV2 MC0●

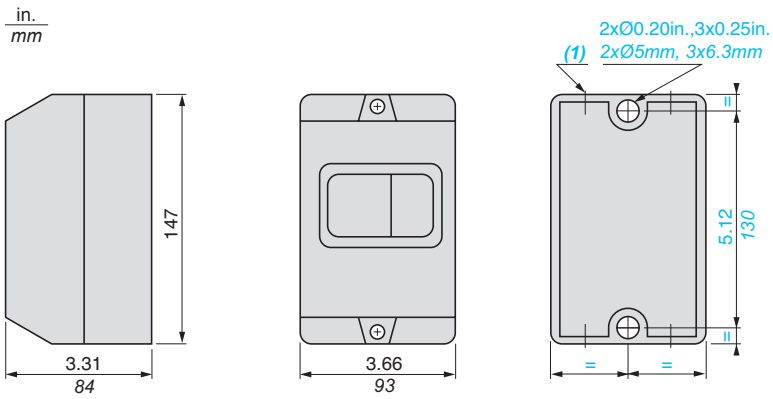

(1) 4 knock-outs for 0.63 (16 mm) plastic cable gland or 0.63 (16 mm) conduit

Life Is On



A trusted partner of Schneider Electric

Wildcat Electric Supply/CED

www.wildcatelectric.com

7136760600

adam.burd@wildcatelectric.com

Schneider Electric Industries SAS

35, rue Joseph Monier
CS 30323
F - 92506 Rueil Malmaison Cedex

RCS Nanterre 954 503 439
Capital social 896 313 776 €
www.se.com

Mar-2021
Document Number SEA10BD2210101EN

© 2021 Schneider Electric. All Rights Reserved. Schneider Electric, TeSys, and Life Is On Schneider Electric are trademarks and the property of Schneider Electric, its subsidiaries, and affiliated companies. All other trademarks are the property of their respective owners.

This document has been
printed on recycled paper

