

Logic Controller - Modicon M221

For hardwired architectures

Catalog

February 2019



A trusted partner of Schneider Electric

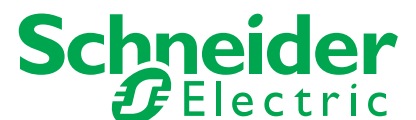

EcoStruxure™ Machine

Innovation At Every Level

To be competitive in today's digital era, machine builders must be innovative. Smart machines, those that are better connected, more flexible, more efficient, and safe, are enabling machine builders to innovate in ways never before possible.

EcoStruxure, Schneider Electric's open, IoT-enabled architecture and platform, offers powerful solutions for the digital era. As part of this, EcoStruxure Machine brings powerful opportunities for machine builders and OEMs, empowering them to offer smart machines and compete in the new, digital era.

EcoStruxure Machine brings together key technologies for product connectivity and edge control on premises, and cloud technologies to provide analytics and digital services. EcoStruxure Machine helps you bring more innovation and added value to your customers throughout the entire machine life cycle.

Innovation at Every Level for Machines is full systems across three layers:

- Connected products
Our connected products for measuring, actuating, device level monitoring, and control adhere to open standards to provide unmatched integration opportunities and flexibility
- Edge Control
We are IIoT-ready with a proven set of tested and validated reference architectures that enable the design of end-to-end open, connected, and interoperable systems based on industry standards. Ethernet and OPC UA facilitates IT/OT convergence meaning machine builders reap benefits from web interfaces and cloud.

- Apps, Analytics & Services
Seamless integration of machines to the IT layer allows the collection and aggregation of data ready for analysis – for machine builders and end users alike this means increased uptime and the ability to find information faster for more efficient operations and maintenance.

These levels are completely integrated from shop floor to top floor. And we have cloud offers and end-to-end cybersecurity wrapped around.

EcoStruxure Machine makes it easier for OEMs/ machine builders to offer their customers smarter machines. The advent of smart machines is driven by the changing needs of end users:

- Evolving workforce
- Reducing costs
- Dynamic markets
- Shorter life cycles
- Prioritizing safety and cybersecurity

EcoStruxure Machine provides one solution for the whole machine life cycle:

- With Smart Design & Engineering the time to market is reduced by up to 30% using our automated engineering and the simulation capabilities
- During Commissioning & Operation of the machine, resources such as energy, material and loss can be improved, and with seamless integration to the IT world efficiency can be improved by up to 40%
- Smart Maintenance & Services reduces the time for corrective actions up to 50%

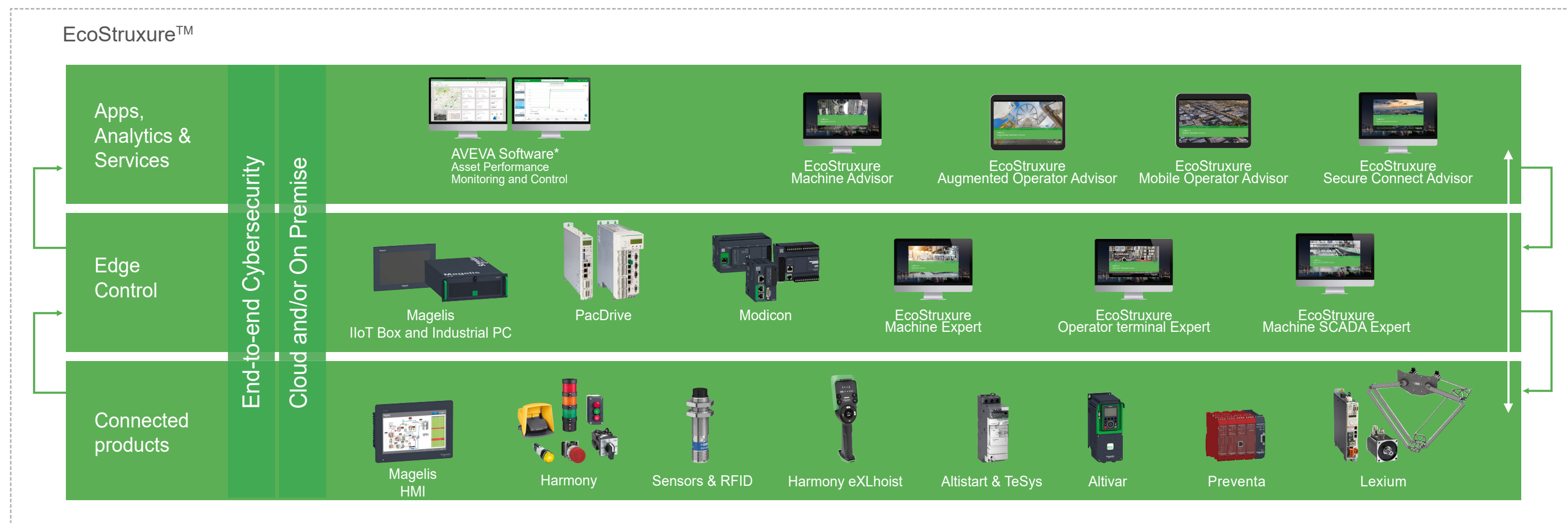

* The Schneider Electric industrial software business and AVEVA have merged to trade as AVEVA Group plc, a UK listed company. The Schneider Electric and Life is On trademarks are owned by Schneider Electric and are being licensed to AVEVA by Schneider Electric.

Quick access to Product information

Select your Catalogue, your Training

Digi-Cat

The complete digital catalogue for industrial automation



Makes your choice easy every day, everywhere!



With just 3 clicks, you can reach the 7,000 pages of the Industrial Automation & Control catalogue, in both English and French.

- Digi-Cat is available on a USB key (for PC). To get your Digi-Cat, please contact your local center
- Download Digi-Cat from this address:

<http://digi-cat.schneider-electric.com/download.html>

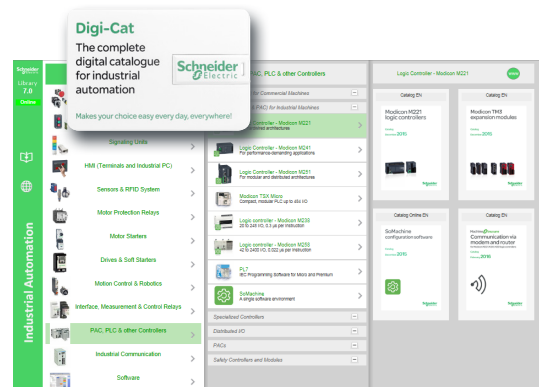

Find your training

- Find the right training for your needs
- Locate the training center with the selector tool, using this address:

<http://www.schneider-electric.com/b2b/en/services/training/technical-training.jsp>

then click on

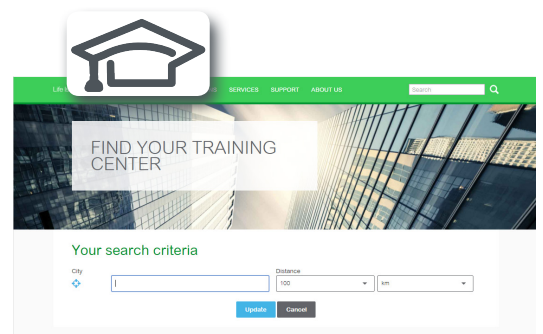
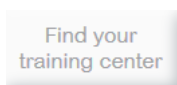

Life Is On



General content

Modicon™ M221 and Modicon™ M221 Book Logic controllers

■ General presentation	
- Empowering industrial OEMs for the digital era	Page 2
- Fastest and smallest logic controllers on the market.....	Page 3
- Modicon M221: the small yet powerful logic controller for hardwired solutions.....	Page 3
- Intuitive machine programming with EcoStruxure™ Machine Expert - Basic	Page 4
■ Selection guide for Modicon™ M221 and Modicon™ M221 Book logic controllers	Pages 6 and 7
■ Presentation	
- Applications, key features.....	Page 8
- Embedded communication, Embedded functions.....	Page 9
- Options: memory card, cartridges.....	Page 9
- Remote graphic display	Pages 10 and 11
- Communication via modem and router	Page 12
- I/O extensions with Modicon TM3 expansion modules	Page 13
- Control architecture for standalone machines.....	Page 14
- Communication	Page 15
■ Description	
- Modicon M221 logic controllers	Page 16
- Modicon M221 Book logic controllers	Page 17
- TMH2GDB Remote graphic display.....	Page 16
■ References	
- Modicon M221 logic controllers	Page 18
- Modicon M221 Book logic controllers	Page 19
- Remote graphic display, Options	Page 20
- Options, separate parts, software, cordsets.....	Page 21
■ Products reference index	Page 22

Empowering industrial OEMs for the digital era

To be competitive in today’s digital era, machine builders must be innovative. Smart machines, those that are better connected, more flexible, more efficient, and safe, are enabling machine builders to innovate in ways never before possible.

- > EcoStruxure™ Machine, our open, interoperable, IoT-enabled system architecture helps you build smarter machines and equipment faster, making your business more efficient, profitable, and sustainable
- > EcoStruxure Machine brings together key technologies for product connectivity and edge control on premises, and cloud technologies to provide analytics and digital services
- > EcoStruxure Machine helps you bring more innovation and added value to your customers throughout the entire machine life cycle

Ready-to-use architectures and function blocks

Tested, Validated, and Documented Architectures (TVDA) are just one of the ways we help you reduce design time. Whether your machines are simple or complex, Application Function Blocks (AFBs) make system design fast and easy.

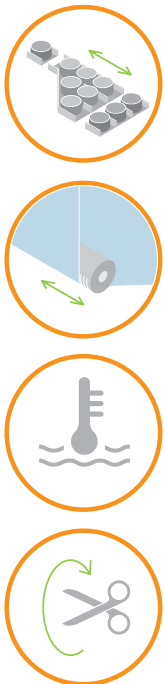

Application Function Blocks (AFB)

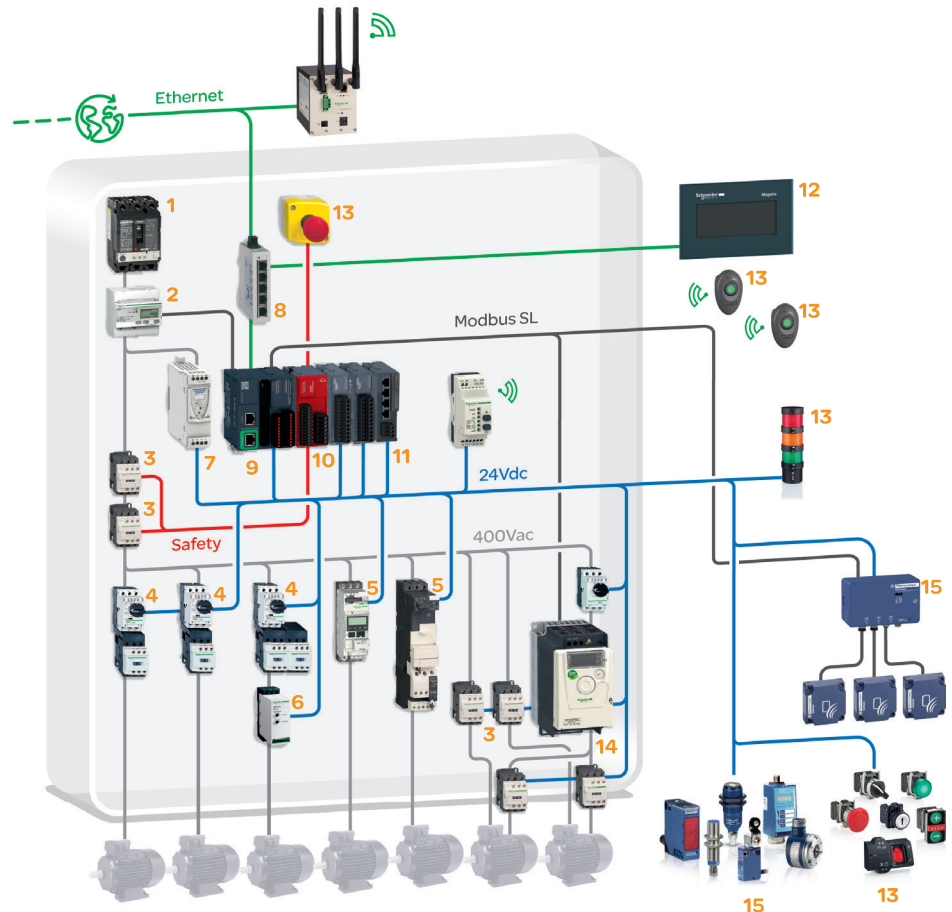

- | | |
|--|--|
| 1 POWERPACT circuit breaker | 10 Modicon TM3 safety I/O module, digital/analog I/O modules |
| 2 Energy meter Acti9 iEM310 iEM310 | 11 Modicon TM3 TeSys motor starter module |
| 3 TeSys D contactor | 12 Magelis display |
| 4 TeSys GV2P motor circuit-breaker | 13 Harmony signalling and control devices |
| 5 TeSys U starter-controller | 14 Altivar 312 variable speed drive |
| 6 Multi9 circuit-breaker C60N | 15 OsiSense: ethernet switch (unmanaged) |
| 7 Phaseo power supply 24 V $\overline{\text{---}}$ | |
| 8 Ethernet switch (unmanaged) | |
| 9 Modicon M221 Book logic controller | 15 OsiSense: limit switches and inductive sensors |

Fastest and smallest logic controllers on the market

Flexible and scalable machine control

The ranges of Modicon™ controllers provide flexible and scalable machine control. Ethernet connectivity, USB port for programming, and an embedded web server: it's all included.



From logic to motion control, the Modicon range offers flexibility and scalability to suit your needs

Modicon M221: the small yet powerful logic controller for hardwired solutions

Everything you need is embedded

The Modicon M221 offers best-in-class performance. Available also in book format, the Modicon M221 requires minimal installation and offers tremendous versatility.

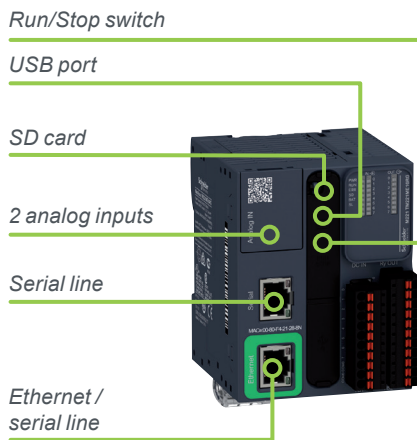

Modicon M221 Book and a broad choice of I/O extension modules

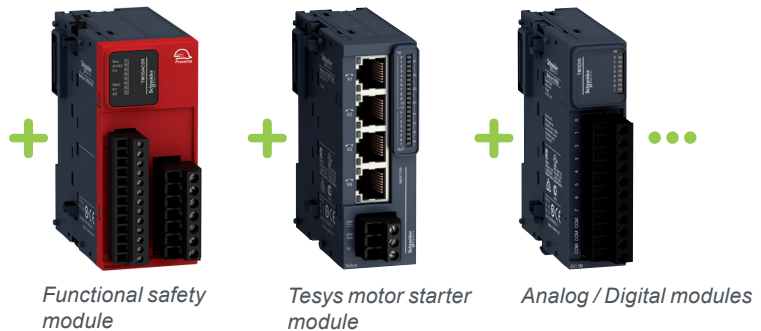

- > SD card, Run/Stop switch, USB port, 2 analog inputs, serial line, Ethernet and serial line, cartridge extension (on standard version): it's all **embedded**.
- > Thanks to its high degree of **flexibility**, it's very easy to add additional modules (safety modules, Tesys motor starter module, extensive line of analog and digital modules, ...) - and still keep everything in **just one configuration**

▲ Available 1st semester 2019

Modicon M221: the small yet powerful logic controller for hardwired solutions

Intuitive machine programming with EcoStruxure Machine Expert - Basic

EcoStruxure Machine Expert - Basic is the universal programming software for machines automated by Modicon M221 logic controllers. Simple navigation that requires only fewer clicks delivers a more efficient engineering process.

- > All programming, visualization, and commissioning are handled in just one intuitive tool that is available as a free download.
- > No training required



EcoStruxure Machine Expert - Basic simplifies every step in the design and commissioning of your machines

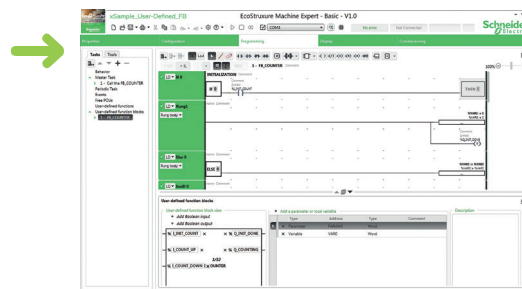

Programming

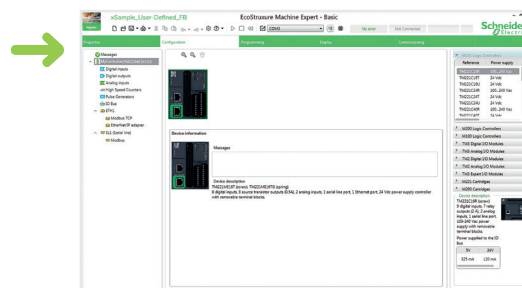

Configuration

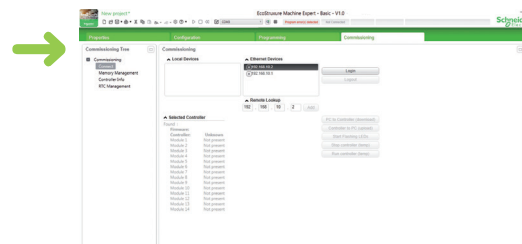

Commissioning

Connected everywhere

For simplified maintenance, commissioning, and uploads/downloads, simply connect anytime, anywhere.

- > Modem and router offer
- > QRcode on the front of the controller

Customization and services



Our experts help you every step of the way, from perfecting machine design to on-site services of the finished machine. Global support, 24/7 hotline services, and replacement parts centers around the world enable you to deliver superior customer support and satisfaction.



Achieve benchmark performance
while increasing profitability



Modicon M221 and M221 Book logic controllers

Applications	Control of simple machines						Control of simple machines		
									
Supply voltage	100-240 V ~	24 V ~	24 V ~	100-240 V ~	24 V ~	24 V ~	100-240 V ~	24 V ~	24 V ~
Inputs/outputs	16 logic I/O 9 sink/source 24 V ~ inputs, inc. 4 high-speed inputs 9 sink/source 24 V ~ inputs, inc. 4 high-speed inputs 9 sink/source 24 V ~ inputs, inc. 4 high-speed inputs 14 sink/source 24 V ~ inputs, inc. 4 high-speed inputs 14 sink/source 24 V ~ inputs, inc. 4 high-speed inputs 14 sink/source 24 V ~ inputs, inc. 4 high-speed inputs						40 logic I/O 24 sink/source 24 V ~ inputs, inc. 4 high-speed inputs 24 sink/source 24 V ~ inputs, inc. 4 high-speed inputs 24 sink/source 24 V ~ inputs, inc. 4 high-speed inputs		
	24 logic I/O 7 relay outputs 7 source transistor outputs, inc. 2 high-speed outputs 7 sink transistor outputs, inc. 2 high-speed outputs 10 relay outputs 10 source transistor outputs, inc. 2 high-speed outputs 10 sink transistor outputs, inc. 2 high-speed outputs						16 logic I/O 8 sink/source 24 V ~ inputs, inc. 4 high-speed inputs 8 sink/source 24 V ~ inputs, inc. 4 high-speed inputs 8 sink/source 24 V ~ inputs, inc. 4 high-speed inputs		
	On removable screw terminal block 2 x 0...10 V analog inputs On dedicated removable connector						On removable screw terminal block or spring terminal block (1) 2 x 0...10 V analog inputs On dedicated removable connector		
	On HE 10 connector (with the Telefast Modicon ABE7 pre-wired system: connection cables and sub-bases)								
I/O extension	Max. number of I/O expansion modules that can be connected /with bus expansion modules <input type="checkbox"/> 7 Modicon TM3 expansion modules, along with limited number of outputs. <input type="checkbox"/> 14 Modicon TM3 expansion modules with the use of bus expansion modules (transmitter and receiver), along with limited number of outputs. <input type="checkbox"/> Possible use of Modicon TM2 expansion modules with restrictions.						<input type="checkbox"/> 7 Modicon TM3 expansion modules, along with limited number of outputs. <input type="checkbox"/> 14 Modicon TM3 expansion modules with the use of bus expansion modules (transmitter and receiver), along with limited number of outputs. <input type="checkbox"/> Possible use of Modicon TM2 expansion modules with restrictions.		
Embedded communication	Ethernet link 1 Ethernet port on TM221CE... controllers: Modbus TCP communication (client & server), slave Modbus TCP, DHCP Client dynamic configuration, programming, downloading, monitoring, EtherNet/IP adapter Serial link 1 serial link port (RJ 45 connector) RS 232/RS 485 with + 5 V supply						Ethernet link 1 Ethernet port on TM221ME... controllers: Modbus TCP communication (client & server), slave Modbus TCP, DHCP Client dynamic configuration, programming, downloading, monitoring, EtherNet/IP adapter Serial link 1 serial link port (RJ 45 connector) RS 232/RS 485 with + 5 V supply 1 additional serial link port on TM221M... controllers (RJ 45) RS 485		
	PID Up to 4 high-speed counter inputs (HSC), 100 kHz frequency Position control (PTO), with trapezoidal profile and S curve able to control either: <input type="checkbox"/> 2 axes in "pulse direction" (P/D) mode <input type="checkbox"/> 1 axis in CW/CCW mode						PID Up to 4 high-speed counter inputs (HSC), 100 kHz frequency Position control (PTO), with trapezoidal profile and S curve able to control either: <input type="checkbox"/> 2 axes in "pulse direction" (P/D) mode <input type="checkbox"/> 1 axis in CW/CCW mode		
Embedded functions	Process control Counting Position control						Process control Counting Position control		
Format	W x H x D 3 controller sizes: 95 x 90 x 70 mm 3.74 x 3.54 x 2.75 in. 110 x 90 x 70 mm 4.33 x 3.54 x 2.75 in. 163 x 90 x 70 mm 6.41 x 3.54 x 2.75 in.						1 size only: 70 x 90 x 70 mm 2.75 x 3.54 x 2.75 in.		
Options	<input type="checkbox"/> 3 analog I/O expansion cartridges <input type="checkbox"/> 1 additional serial link communication cartridge <input type="checkbox"/> 3 application cartridges - for control of hoisting applications - for control of packaging applications - for control of conveying applications								
	Number of cartridge slots <input type="checkbox"/> Display unit								
Mounting	TMH2GDB remote graphic display: visualization and monitoring Mounting on L symmetrical rail or panel with specific mounting kit TMAM2						TMH2GDB remote graphic display: visualization and monitoring Mounting on L symmetrical rail or panel with specific mounting kit TMAM2		
Software programming	With EcoStruxure Machine Expert - Basic software						With EcoStruxure Machine Expert - Basic software		
Logic controller type	Modicon M221 Controllers without Ethernet port TM221C16R TM221C16T TM221C16U TM221C24R TM221C24T TM221C24U Controllers with embedded Ethernet port TM221CE16R TM221CE16T TM221CE16U TM221CE24R TM221CE24T TM221CE24U						Modicon M221 Book TM221M16R TM221M16T TM221M32TK TM221M16RG (1) TM221M16TG (1) TM221ME16R TM221ME16T TM221ME32TK TM221ME16RG (1) TM221ME16TG (1)		
	Pages 18						Pages 19		

(1) Spring terminal block on references ending in the letter G.

Modicon M221 and M221 Book logic controllers

General presentation



16 I/O channels



24 I/O channels



40 I/O channels

Modicon M221 logic controllers (standard format)



16 I/O channels



32 I/O channels

Modicon M221 Book logic controllers

Presentation

Applications

Modicon M221 and M221 Book logic controllers are designed for simple machines. They can optimize the size of wall-mounted and floor-standing control system enclosures due to their compact dimensions.

- The controllers are available in 2 formats:
 - Modicon M221 controllers (TM221C●●●● references) offer excellent connection capacity and customization options without increasing the controller size, using I/O, communication, or application cartridges.
 - Modicon M221 Book controllers (TM221M●●● references) offer very small dimensions and a wide choice of connections.
- M221 and M221 Book controllers have an embedded Ethernet port meaning they can be easily integrated in control system architectures, for remote control and maintenance of machines using applications for smartphones, tablets, and PCs.
- The wealth of functions embedded in M221 and M221 Book controllers minimizes the cost of the machine:
 - Functions embedded in the controller: Modbus serial link, USB port dedicated to programming, and simple position control functions (high speed counters and pulse train outputs trapezoidal and S-curve profile)
 - Functions embedded in Modicon TM3 extensions: functional safety modules, motor-starter control module, and remote expansion system
 - Functions embedded in the dedicated display unit
- The application is created quickly thanks to the intuitive nature of the EcoStruxure Machine Expert - Basic programming software, which also has embedded configuration of the display unit and extensions, including the functional safety modules.

Main functions

Modicon TM221C●●●	Modicon TM221M●●●
w x h x d (mm/in.)	
<ul style="list-style-type: none"> □ 16 I/O: 95 x 90 x 70 / 3.74 x 3.54 x 2.75 □ 24 I/O: 110 x 90 x 70 / 4.33 x 3.54 x 2.75 □ 40 I/O: 163 x 90 x 70 / 6.41 x 3.54 x 2.75 	<ul style="list-style-type: none"> □ 16 I/O: 70 x 90 x 70 / 2.75 x 3.54 x 2.75 □ 32 I/O: 70 x 90 x 70 / 2.75 x 3.54 x 2.75
Supply voltage	
24 V $\overline{\text{---}}$ or 100..240 V \sim 50/60 Hz	24 V $\overline{\text{---}}$
Connection of the embedded I/O	
On removable screw terminal blocks at intervals of 5.08 mm (0.20 in.) 24 V I/O, 25 A power supply provided by the controller for sensor inputs on TM221C●●●R models	16 I/O: On removable screw or spring terminal blocks at intervals of 3.81 mm (0.15 in.) 32 I/O: On HE10 connectors with HE 10 cables/bare wires or Telefast ABE7 connection sub-bases (1)
Analog inputs	
2 embedded inputs on each TM221M●●● and TM221C●●● controller	
Embedded Ethernet communication	
Yes on TM221CE●●	Yes on TM221ME●●
Serial link	
1 embedded link	1 or 2 embedded links
Cartridges	
1 slot for 1 or 2 cartridges: <ul style="list-style-type: none"> □ I/O cartridge (analog inputs or outputs, temperature inputs) □ communication cartridge (serial link) or application cartridges (hoisting, conveying, and packaging) 	–

Hardware characteristics

- M221 and M221 Book controllers each have an embedded:
- Run/Stop switch
 - slot for an industrial SD memory card
 - QR code for direct access to its technical documentation

(1) Telefast Modicon ABE7 pre-wired system to be ordered separately. Refer to the catalog ref. [DIA3ED2160602EN](#) or our website www.schneider-electric.com

Modicon M221 and M221 Book logic controllers

General presentation, options for Modicon M221 and M221 Book logic controllers



EcoStruxure Machine Expert - Basic software

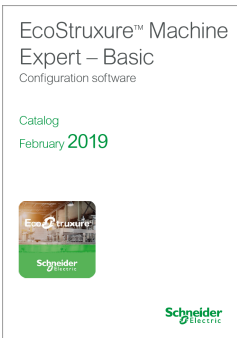

Please consult catalog Ref. DIA3ED2181201EN



TMASD1 industrial SD memory card



M221



M221 Book



Analog I/O cartridges



Communication cartridge



Application cartridges



M221

Presentation

Embedded communication (see page 15)

M221 and M221 Book logic controllers have three types of integrated communication port:

- Ethernet
- RS 232/RS 485 serial link
- USB mini-B programming port

Embedded functions

Each Modicon M221 and M221 Book logic controller has the following integrated functions:

- Analog (PID control)
- Counting: Up to 4 high speed counters (HSC), 100 kHz frequency
- Controllers with transistor logic outputs (source or sink) are equipped with 2 or 4 high speed counters (1) supporting pulse generation functions.
- Position control (PTO), with trapezoidal and S-curve profile able to control either:
 - 2 or 4 axes in pulse direction (P/D) mode
 - 1 or 2 axes in CW/CCW mode
 These outputs can be associated with event-triggered inputs to feed back homing and capture information. A "Motiontask" function block (one per axis) associated with a command table can be used to program and preview intuitively all the movements of an axis in the EcoStruxure Machine Expert - Basic software.
- Pulse width modulation (PWM)
- Pulse generator (PLS)
- Frequency generator (FREQGEN)

Processing power

- Execution speed: 0.2 μs/Boolean instruction
- Program: 10 Boolean Kinstructions
- Number of words: 8,000. Number of internal bits: 1,024
- RAM: 640 K (256 K for internal variables and 256 K for application and client data)
- Flash memory: 2 MB (including 256 K for backing up the client application and data in the event of a power outage)

Programming

Modicon M221 and M221 Book logic controllers are programmed using EcoStruxure Machine Expert - Basic software available on our website: www.schneider-electric.com

Options

Memory card

The **TMASD1** industrial SD memory card, with 256 MB capacity, is available for Modicon M221 and M221 Book logic controllers. It is used for:

- backing up and transferring applications
- loading firmware
- duplicating applications between controllers
- data logging

Cartridges

One or two cartridges can be inserted on the front of TM221C●●● controllers without increasing the dimensions.

Three types of cartridge are offered:

- Analog I/O cartridges
 - TMC2AI2** for 2 analog inputs, which can be configured as voltage or current
 - TMC2AQ2V** for 2 voltage analog outputs
 - TMC2AQ2C** for 2 current analog outputs
 - TMC2TI2** for 2 temperature inputs
- Communication cartridge
 - TMC2SL1** providing additional serial link port terminals for connection via a printer, barcode reader, etc.
- Application cartridges
 - TMC2HOIS01** for hoisting applications with two dedicated analog inputs for controlling a load cell
 - TMC2PACK01** for packaging applications with two dedicated analog inputs for controlling the temperature on a packaging machine
 - TMC2CONV01** for conveyor system applications with a serial link
 Use of an application cartridge provides direct access to application examples via the EcoStruxure Machine Expert - Basic software.

(1) 4 high-speed outputs on TM221C●40U, 2 high-speed outputs on TM221●●16T, TM221C●24T, TM221C●40T, TM221C●16U, TM221C●24U.

Modicon M221 and M221 Book logic controllers

Remote graphic display unit for Modicon M221 and M221 Book logic controllers

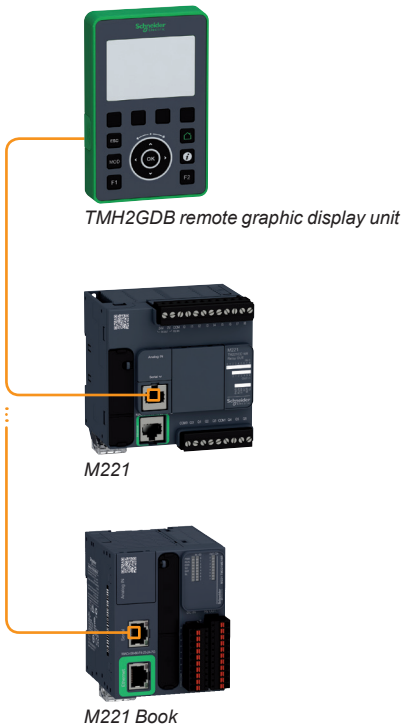

TMH2GDB remote graphic display unit

Presentation

The **TMH2GDB** remote graphic display unit is an HMI dedicated to M221 and M221 Book logic controllers. It is mounted on the front panel of a wall-mounted or floor-standing enclosure (degree of protection IP 65) or, using mounting brackets, at the back of an enclosure on a panel or symmetrical rail.

The **TMH2GDB** display unit is ready to use: the main application parameters can be accessed, with no prior programming, as soon as it is connected to the logic controller. Customized dialog pages can, however, be easily created using predefined templates in the EcoStruxure Machine Expert - Basic software dedicated to Modicon M221 and M221 Book logic controllers.

The **TMH2GDB** remote graphic display unit is a multifunction display unit that runs alongside your machine throughout its life cycle:

- During debugging: reading the states and values of variables and providing complete diagnostics of the controller configuration
- During installation: options for setting the time and configuring the communication ports
- During runtime: an operator interface created in the EcoStruxure Machine Expert - Basic software can be used to (for example):
 - display information in the form of text, values, bargraphs, or gages
 - perform machine control actions
 - enter or modify data
 - customize buttons on the front panel
- During maintenance: the page displaying alarm messages is permanently accessible by pressing a single key. Alarm messages are stored and time-tagged in a page of the log. An icon, which is always visible, flags up the presence of at least one alarm message. Access to each page and modification of its values can be protected by a password.

Main characteristics

- Backlit monochrome STN LCD 60 x 40 mm (2.36 x 1.57 in.)
- 5 lines of 20 to 35 characters, depending on the type of page
- Title block at the top of the page
- Title block at the bottom of the page
- 10 languages available: English, French, Czech, German, Italian, Japanese, Portuguese, Simplified Chinese, Spanish, and Turkish
- Up to 4 customizable service keys
- 100 HMI pages maximum
- Dimensions on the front panel of the machine (w x h x d): 80 x 126 x 19.2 mm (3.15 x 4.96 x 0.75 in)

Conformity

- CE, cULus Listing Mark

Environmental characteristics

- Ambient operating temperature: -15...+ 50 °C (5...122 °F)

Power supply characteristics

- 5 V $\overline{\text{DC}}$ (200 mA) supplied directly by the controller
- Max. consumption: 1 W

Modicon M221 and M221 Book logic controllers

Remote graphic display unit for Modicon M221 and M221 Book logic controllers

TMH2GDB remote graphic display unit (continued)

Installation and setup

The **TMH2GDB** remote graphic display unit is mounted in a 22 mm (0.87 in.) diameter hole and is connected to the SL or SL1 serial link on Modicon M221 and M221 Book logic controllers with the **XBTZ9980** and **VW3A1104R10** cable, which also supplies it with power (no other Modbus slave equipment must be connected on this link) (1).

The debug screens, including those for setting the time and configuring the communication ports, are already configured and available as soon as the display unit is connected to the logic controller (2).

The HMI (runtime) pages and alarm pages are created and configured very easily in the EcoStruxure Machine Expert - Basic programming software, from predefined pages:

- "Alarm display" template
- "Menu" template
- "Monitoring" template
- "Control panel" template
- "Bargraph" template (1 or 2 bars)
- "Gage" template

These pages constitute part of the controller application. They are transferred to and stored in the M221 and M221 Book logic controller memory, no transfer is necessary between the PC and the **TMH2GDB** graphic display unit. The latter is operational as soon as it is connected to the serial port on the logic controller.

The Home page can be selected by programming. Each HMI and alarm page can be displayed by navigating the front panel using the keys or called by a program. Alarm pages can also be displayed on a red background.

The HMI pages can be created in several languages, the language displayed on the graphic display unit can then be selected by the operator in the display configuration menu.

(1) Neither the serial link on the TMC2SL1 cartridge, nor the SL2 embedded serial link, can be used to connect the graphic display unit.

(2) When the controller has no application program, only the product reference and the controller firmware version are accessible. The controller firmware version must be V1.3 or later.

Controller Info		10/02/2012 02:57:11
Device name	TM221CE24T	
Firmware version	0.39.1	
LastMAST cycle	0,134 ms	
Min. MAST cycle	0,134 ms	
Max. MAST cycle	0,159 ms	
Alarm		Back

Debugging: Controller information

Ethernet		10/02/2012 02:57:47
IP Mode	0	
IP address	85.21.1.24	
Mask	255.255.255.0	
Gateway	0.0.0.0	
Device name	M221	
Apply	Edit	Refresh
		Cancel

Debugging: Configuring communication

Alarm	Monitoring	26/11/2014 10:38:24
Temperature 1	23	
Temperature 2	24	
Heating	1	
Cooling	0	
Auto/Manu	1	
Edit	Alarm	menu

HMI: Monitoring

Alarm	Controls	26/11/2014 10:38:40
Auto mode status		
Auto mode selected		
Oven is heating		
Cooling system is OFF		
On	Off	Menu
		Alarm

HMI: Control panel

WATER SUPPLY		14/09/2015 23:26:13
3	m	
0 10		
9	m3	
0 10		
Edit1	Edit2	Alarm
		Home

HMI: Bargraph

Temperature		10/02/2012 02:58:14
20	25	30
----- ----- -----		
22		°C
Alarm	menu	set

HMI: Gage

Alarm	Alarm History	17/09/2015 07:44:18
TANK EMPTY	17/09/2015 07:43:55	
Conveyor blocked	17/09/2015 07:43:36	
LOW BATTERY	17/09/2015 07:41:37	
TANK EMPTY	17/09/2015 07:41:00	
Alarm	Delete	Back

HMI: Alarm display

Examples of screens

Modicon M221 and M221 Book logic controllers

Communication via modem and router

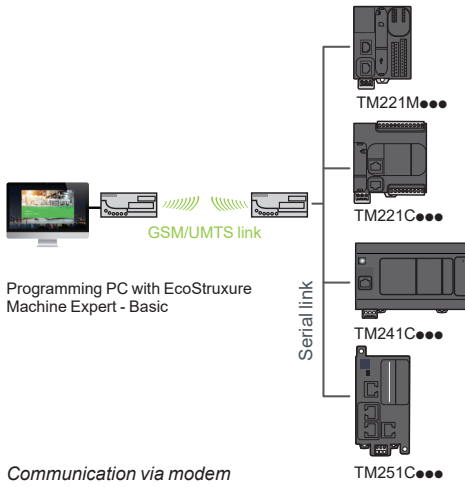

Communication via modem and router

The communication via modem and router offer is dedicated to the following applications:

- Synchronization between remote machines; direct data exchange between controllers
- Remote maintenance; access to the controller via the EcoStruxure Machine Expert - Basic programming software
- Remote control and monitoring of machines; receipt of information and sending commands on GSM/UMTS phone (1)

This offer comprises a **Schneider Electric** modem, a GSM/UMTS modem, and an **eWon** VPN router.

For modem and router, please consult our website www.schneider-electric.com.

(1) Global System Mobile (2G)/Universal Mobile Telecommunications System (3G)

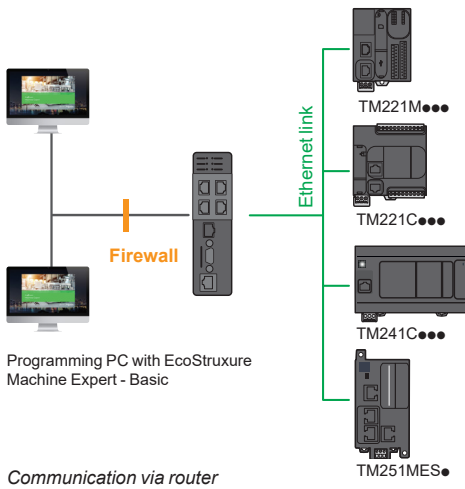

Modicon M221 and M221 Book logic controllers

I/O extensions with Modicon TM3 expansion modules

I/O extensions with Modicon TM3 modules

Modicon TM3 expansion modules

The capacity of M221 and M221 Book logic controllers can be enhanced with the Modicon TM3 expansion module offer:

- Digital I/O modules that can be used to create configurations with up to 488 digital I/O. These modules are available with the same connections as the controllers.
- Analog I/O modules that can be used to create configurations with up to 114 analog I/O and are designed to receive, amongst other things, position, temperature, and speed sensor signals. They are also capable of controlling variable speed drives or any other device equipped with a current or voltage input.
- Expert module for control of TeSys motor-starters, connected with RJ 45 cables to simplify wiring up the control section.
- Functional safety modules that simplify wiring and can be configured in the EcoStruxure Machine Expert - Basic software.

In addition, the TM3 expansion system is flexible due to the possibility of remotely locating some of the TM3 modules in the enclosure or another cabinet, up to 5 meters (16.404 ft) away, using a bus expansion system.

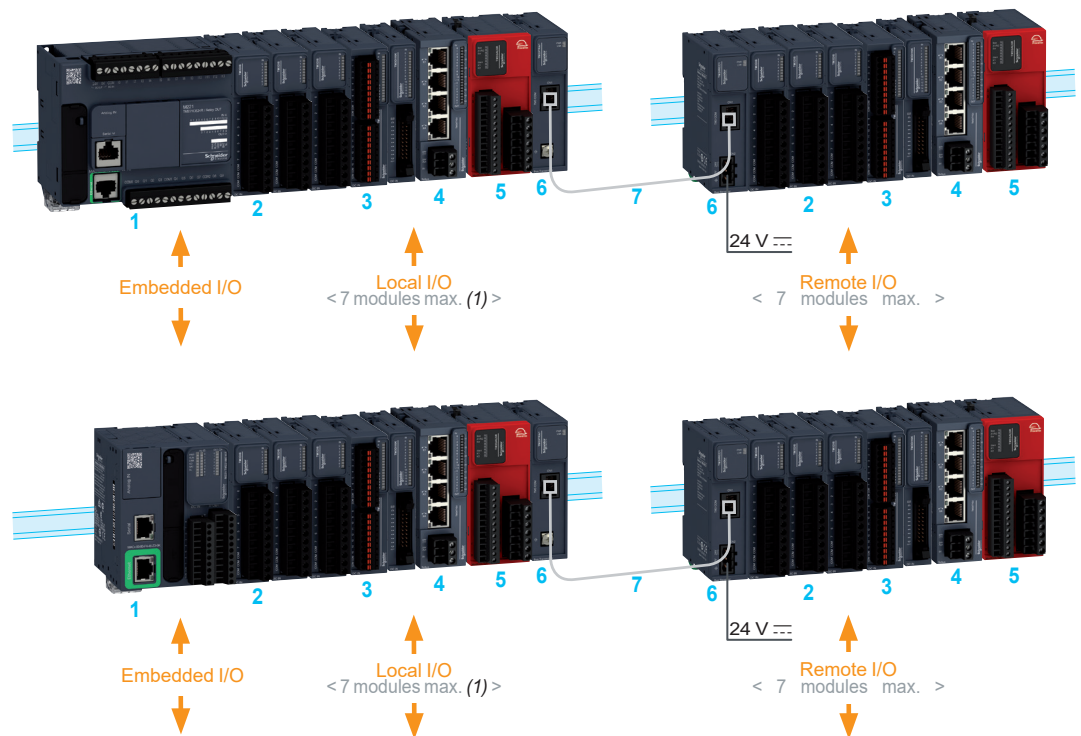

- 1 Modicon M221/M221 Book logic controller
- 2 Modicon TM3 digital I/O modules
- 3 Modicon TM3 analog I/O modules
- 4 Modicon TM3 expert module: control of TeSys motor-starters
- 5 Modicon TM3 functional safety modules
- 6 Modicon TM3 bus expansion modules (transmitter and receiver)
- 7 TM3 bus expansion cable

(1) Depending on the type of TM3 module used.

Modicon M221 and M221 Book logic controllers

Control architecture

Control architecture for standalone machines

Typical applications: repetitive machines

- Packaging: recycling machines
- Textile-clothing machines
- Commercial equipment: automatic wash units, advertising hoardings, etc.
- Construction/service sector: access and entry control for automated systems
- Other sectors: woodworking, agriculture, fish farming, incubators, swimming pools, etc.

■ M221 (TM221C●●●●) controllers

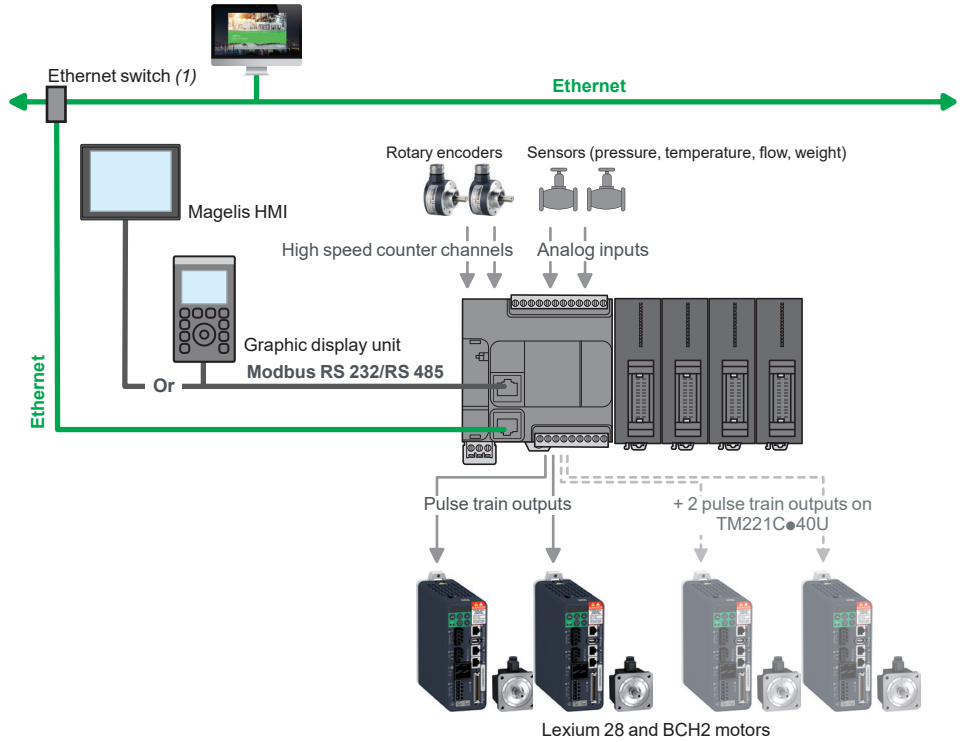

■ M221 Book (TM221M●●●) controllers

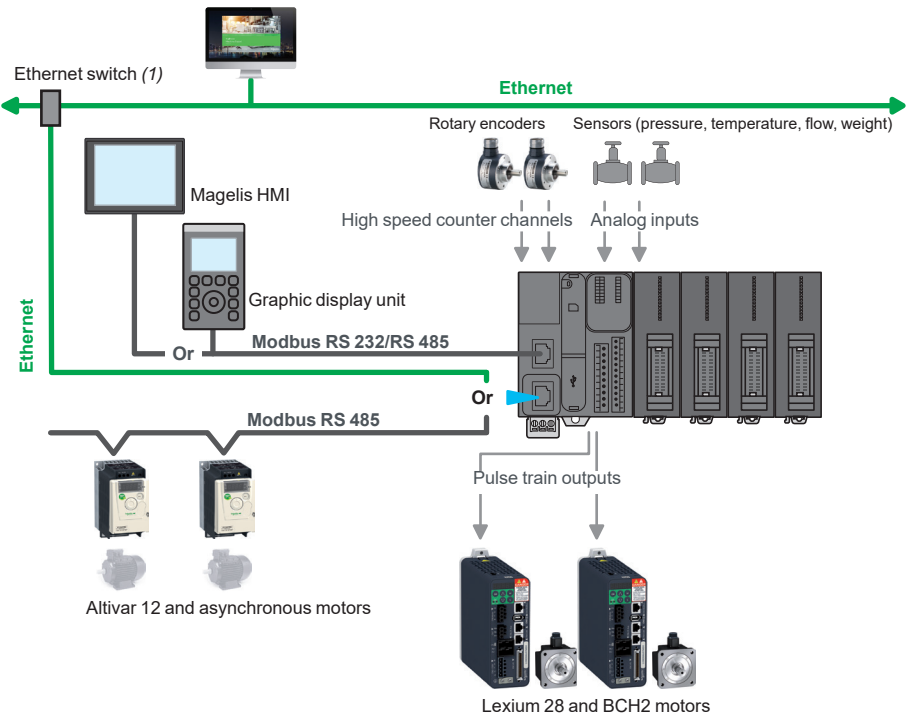

(1) Only use one switch, as Hubs are not compatible.

Modicon M221 and M221 Book logic controllers

Embedded communication Characteristics

Embedded communication

Communication on Ethernet network

TM221CE●●● and TM221ME●●● controllers have an embedded RJ 45 Ethernet port (10/100 Mbps, MDI/MDIX) with Modbus TCP (Client/Server and IOScanner), and Ethernet IP (adapter) protocols.

- As well as the default address based on the MAC address, it is possible to assign the controller IP address via a DHCP server or via a BOOTP server.
- The Ethernet port also offers the same application upload/download, update, and debug functions when the controller is supplied with power.
- A firewall can be used to lock each communication protocol.

For connection cables and accessories for Industrial Ethernet network, please refer to our catalogue ref. [DIA3ED2160105EN](#)

Serial links

■ Each TM221C●●● controller has an embedded serial link that can be configured as RS 232 or RS 485. A 5 V/200 mA power supply is available on the RJ 45 connector, which then supplies the **TMH2GDB** display unit or Magelis **XBTN** or **XBTRT** HMI.

■ Each TM221M●●● controller has one or two embedded serial links.

- The SL1 serial link, found on each M221 Book controller, can be configured as RS 232 or RS 485. A 5 V/200 mA power supply is available on the RJ 45 connector, which then supplies the **TMH2GDB** display unit, Magelis **XBTN** or **XBTRT** HMI, or other device.
- The SL2 serial link, found on TM221M16●●●, TM221M24●●● and TM221M40●●● controllers only, is configured as RS 485.

Serial links also offer application upload/download, update, and debug functions when the controller is supplied with power. Embedded in both links are the three main commercially-available protocols:

- Modbus ASCII/RTU Master or Slave
- ASCII character string
- Modbus Serial IOScanner

For connection cables and accessories for serial link, please refer to our catalogue ref. [DIA3ED2160106EN](#)

Software programming with power off charging function

The programming port, equipped with a USB mini-B connector, is embedded in each M221 and M221 Book controller; it is dedicated to communication with a PC equipped with EcoStruxure Machine Expert - Basic for programming, debugging, and maintenance.

In addition, it offers the ability to load an application program or update the firmware without the controller being powered by another source.

Characteristics of logic controllers

- Certifications: CE, UL Listing Mark, CSA, RCM, EAC, LR, ABS, DNV - GL
- Standards: IEC/EN 61131-2 (Edition 2 2007), UL 508 (UL 61010-2-201), ANSI/ISA 12.12.01-2007, CSA C22.2 No. 213, No. 142, E61131-2, and IACS E10

Environment

- Ambient operating temperature: - 10...+ 55 °C (14...+ 131 °F)
- Storage temperature: - 25...+ 70 °C (- 13...+ 158 °F)
- Relative humidity: 10...95% (non-condensing)

Operating altitude:

- 0...2,000 m (0...6,562 ft): complete specification for temperature and insulation
- 2,000...4,000 m (6,562...13,123 ft):
 - temperature derating: + 1 °C/400 m (+ 1.8 °F/1,312 ft)
 - insulation losses: 150 V ---/1,000 m (3,280 ft)
- Storage altitude: 0...3,000 m (0...9,842 ft)
- Immunity to mechanical stress (vibrations):
 - For 1131: 5...8.4 Hz (amplitude 3.5 mm/0.138 in.); 8.4...150 Hz (acceleration 1 g)
 - For merchant navy: 5...13.2 Hz (amplitude 1.0 mm/0.039 in.); 13.2...100 Hz (acceleration 0.7g)

Power supply

Two power supply types are available depending on the M221 controller model: 24 V --- or 100-240 V ~ 50/60 Hz

- Voltage limit (including ripple): 19.2...28.8 V ---/85...264 V ~
- Immunity to micro-cuts (class PS-2): 10 ms
- Max. consumption:
 - TM221 powered with AC, depending on model: 31...41 VA without expansion modules, 46...70 VA with maximum expansion module configuration
 - TM221 powered with DC, depending on model: 3.2...4.9 W without expansion modules, 10...23 W with maximum expansion module configuration

Modicon M221 and M221 Book logic controllers

Modicon M221 logic controllers

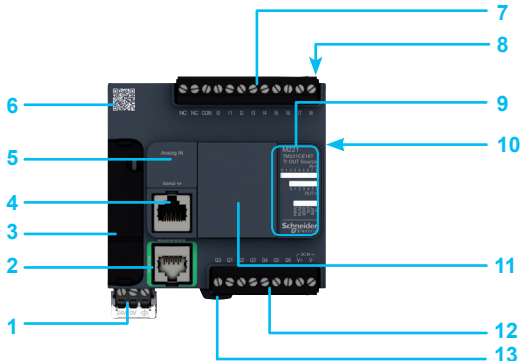

M221: 16 I/O

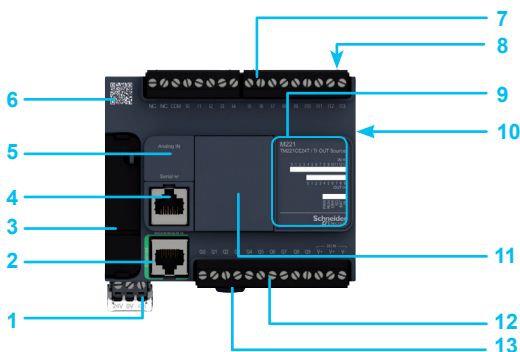

M221: 24 I/O

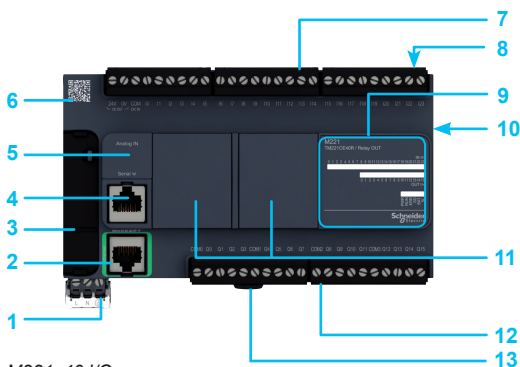

M221: 40 I/O



TMH2GDB

Description

M221 logic controllers (TM221C●●●)

- 1 Removable screw terminal block, 3 terminals for connecting the 24 V $\overline{\text{DC}}$ or 100-240 V \sim power supply (depending on the model)
- 2 On TM221CE●●● controllers: RJ 45 connector for Ethernet network, with activity and exchange speed LED indicator
- 3 Behind the removable cover:
 - Mini-B USB connector for connecting a PC equipped with SoMachine Basic software
 - Slot for the industrial SD memory card
 - Run/Stop switch
- 4 Serial link port (RS 232 or RS 485): RJ 45 connector
- 5 Behind a flap: dedicated removable connector for two analog inputs
- 6 QR code for access to the controller technical documentation
- 7 Connection of 24 V $\overline{\text{DC}}$ logic inputs on removable screw terminal blocks (1)
- 8 On top of the controller: slot for backup battery
- 9 LED display block showing:
 - the status of the controller and its components (battery, industrial SD memory card)
 - the status of the serial link
 - the status of the embedded I/O
- 10 On the side of the controller: TM3 bus connector for the link with a Modicon TM3 expansion module
- 11 Slot(s) for I/O cartridge(s), communication cartridge, or application cartridge(s): one on M221 controllers with 16 and 24 I/O, two on M221 controllers with 40 I/O
- 12 Connection of relay/transistor logic outputs: on removable screw terminal blocks (1)
- 13 Clip for locking on DIN symmetrical rail

(1) Removable screw terminal blocks equipped with screw terminals, supplied with M221 controller.

Graphic display unit TMH2GDB

- 1 Control screen: backlit STN graphic screen, two-tone (white/red)
- 2 Ten command buttons, two of which can be customized with the option of identifying associated functions
- 3 Rotary navigation and control wheel

On the back of the display unit:

- 4 Mounting system consisting of locking nut, seal, and anti-rotation tee
- 5 RJ 45 connector for the cable connecting the graphic display unit to the Modicon M221/M221 Book logic controller

Modicon M221 and M221 Book logic controllers

Modicon M221 Book logic controllers

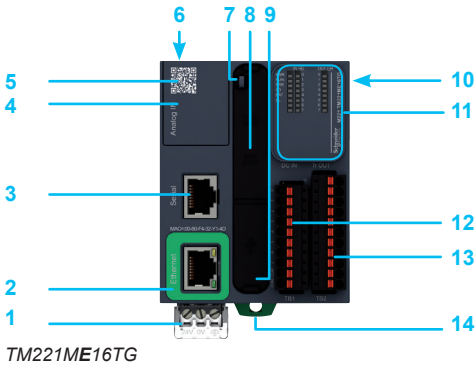

TM221ME16TG

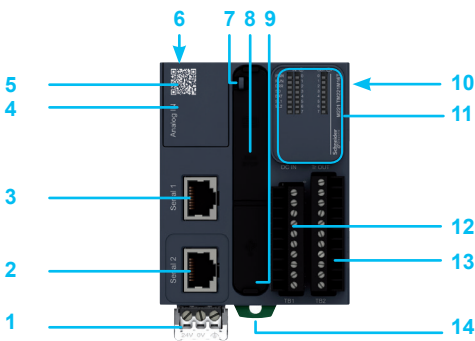

TM221M16T

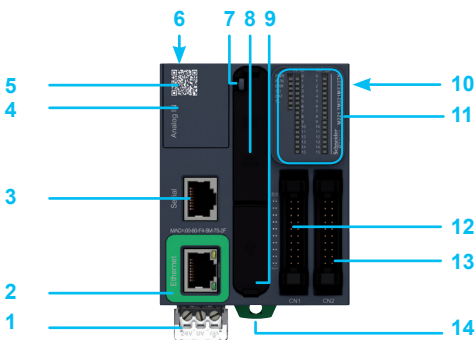

TM221ME32TK



TMH2GDB

Description

M221 Book logic controllers (TM221M●●●)

- 1 Removable screw terminal block, 3 terminals for connecting the 24 V $\bar{\text{c}}$ supply
 - 2 On TM221ME16●● and TM221ME32●● controllers: RJ 45 connector for Ethernet network, with activity and exchange speed LED indicator
On TM221M16●● and TM221M32●● controllers: RJ 45 connector for SL2 serial link
 - 3 SL1 serial link port (RJ 45 connector)
 - 4 Behind the removable cover: removable connector for two analog inputs
 - 5 QR identification code for the controller technical documentation
 - 6 Backup battery slot
- Behind the removable cover: 7, 8, and 9
- 7 Slot for the industrial SD memory card
 - 8 Run/Stop switch
 - 9 Mini-B USB connector for connecting a PC equipped with EcoStruxure Machine Expert - Basic software
 - 10 TM3 bus connector for linking to a Modicon TM3 expansion module
 - 11 LED display block showing:
 - the status of the controller and its components (battery, industrial SD memory card)
 - the status of the serial links
 - the status of the I/O
 - 12 Connection of 24 V $\bar{\text{c}}$ logic inputs:
 - on 16-channel controllers: removable screw or spring terminal blocks (1)
 - on 32-channel controllers: HE10 connector
 - 13 Connection of relay/transistor logic outputs:
 - on 16-channel controllers: removable screw or spring terminal blocks (1)
 - on 32-channel controllers: HE10 connector
 - 14 Clip for locking on $\bar{\text{L}}$ symmetrical rail

(1) Removable terminal blocks equipped with screw or spring-type terminals depending on controller type. Terminal blocks supplied with M221 Book controller.

Graphic display unit TMH2GDB

Description: see page 16

Modicon M221 and M221 Book logic controllers

Modicon M221 logic controllers



TM221C16R, TM221C16T, TM221CE16U



TM221CE16R, TM221CE16T, TM221CE16U



TM221C24R, TM221C24T, TM221CE24U



TM221CE24R, TM221CE24T, TM221CE24U



TM221C40R, TM221C40T, TM221CE40U



TM221CE40R, TM221CE40T, TM221CE40U



TMC2AI2



TMC2AQ2V



TMC2AQ2C



TMC2TI2



TMC2SL1



TMC2PACK01



TMC2HOIS01



TMC2CONV01

References

Modicon M221 logic controllers (1)

Number of logic I/O	Logic inputs	Logic outputs	Analog inputs	Integrated communication ports (2)		Reference	Weight kg/lb
				Ethernet (RJ 45)	Serial link (RJ 45)		
■ 100-240 V ~ power supply							
16 inputs/outputs	9 sink/source 24 V ~ inputs, inc. 4 high-speed inputs	7 relay outputs	2 x 0...10 V inputs	–	1	TM221C16R	0.346 0.763
				1	1	TM221CE16R	0.346 0.763
24 inputs/outputs	14 sink/source 24 V ~ inputs, inc. 4 high-speed inputs	10 relay outputs	2 x 0...10 V inputs	–	1	TM221C24R	0.395 0.871
				1	1	TM221CE24R	0.395 0.871
40 inputs/outputs	24 sink/source 24 V ~ inputs, inc. 4 high-speed inputs	16 relay outputs	2 x 0...10 V inputs	–	1	TM221C40R	0.456 1.005
				1	1	TM221CE40R	0.456 1.005
■ 24 V ~ power supply							
16 inputs/outputs	9 sink/source 24 V ~ inputs, inc. 4 high-speed inputs	7 source transistor outputs, inc. 2 high-speed outputs	2 x 0...10 V inputs	–	1	TM221C16T	0.346 0.763
				1	1	TM221CE16T	0.346 0.763
24 inputs/outputs	14 sink/source 24 V ~ inputs, inc. 4 high-speed inputs	10 source transistor outputs, inc. 2 high-speed outputs	2 x 0...10 V inputs	–	1	TM221C24T	0.395 0.871
				1	1	TM221CE24T	0.395 0.871
40 inputs/outputs	24 sink/source 24 V ~ inputs, inc. 4 high-speed inputs	16 source transistor outputs, inc. 2 high-speed outputs	2 x 0...10 V inputs	–	1	TM221C40T	0.456 1.005
				1	1	TM221CE40T	0.456 1.005
16 inputs/outputs	9 sink/source 24 V ~ inputs, inc. 4 high-speed inputs	7 sink transistor outputs, inc. 2 high-speed outputs	2 x 0...10 V inputs	–	1	TM221C16U	0.558 1.230
				1	1	TM221CE16U	0.626 1.380
24 inputs/outputs	14 sink/source 24 V ~ inputs, inc. 4 high-speed inputs	10 sink transistor outputs, inc. 2 high-speed outputs	2 x 0...10 V inputs	–	1	TM221C24U	0.770 1.698
				1	1	TM221CE24U	0.570 1.257
40 inputs/outputs	24 sink/source 24 V ~ inputs, inc. 4 high-speed inputs	16 sink transistor outputs, inc. 4 high-speed outputs	2 x 0...10 V inputs	–	1	TM221C40U	0.630 1.389
				1	1	TM221CE40U	0.780 1.720

Options for Modicon TM221C logic controllers (3)

Description	Function	Reference	Weight kg/lb
I/O cartridges	2 analog inputs (12-bit resolution) configurable as: - 0...10 V voltage - 0...20 mA/4...20 mA current	TMC2AI2	0.025 0.055
	Screw terminal version		
	2 analog outputs (12-bit resolution) 0...10 V voltage	TMC2AQ2V	0.025
	Screw terminal version		0.055
Communication cartridge	2 analog outputs (12-bit resolution) 4...20 mA current	TMC2AQ2C	0.025
	Screw terminal version		0.055
	2 temperature inputs (12-bit resolution) type K, J, R, S, B, E, T, N, C, PT100, PT1000, NI100, NI1000	TMC2TI2	0.025
	Screw terminal version		0.055
Communication cartridge	1 additional serial link on screw terminal block	TMC2SL1 (4)	0.025 0.055
Cartridges for specific application	Hoisting application	TMC2HOIS01	0.025 0.055
	Packaging application	TMC2PACK01	0.025 0.055
	Conveyor system application	TMC2CONV01 (4)	0.025 0.055

(1) M221 controllers are supplied with:

- removable screw terminal blocks for connecting the I/O
- a removable screw terminal block for connecting the power supply
- a button cell backup battery (BR2032)
- a cable for connecting the analog inputs

(2) Each M221 logic controller has an embedded USB mini-B programming port.

(3) One cartridge for controllers with 16 and 24 I/O. Two cartridges maximum for controllers with 40 I/O, only one of which can be a communication cartridge.

(4) Just one cartridge per controller.

Modicon M221 and M221 Book logic controllers

Modicon M221 Book logic controllers



References									
Modicon M221 Book logic controllers (1)									
24 V $\bar{\square}$ power supply									
No. of logic I/O	Logic inputs	Logic outputs	Analog inputs	Embedded communication ports (2)			Terminal block for I/O conn. Interval (mm/in.)	Reference	Weight kg/lb
				Ethernet (RJ 45)	Serial link SL1 (RJ 45)	SL2 (RJ 45)			
16 inputs/ outputs	8 sink/source 24 V $\bar{\square}$ inputs, inc. 4 high-speed inputs	8 relay outputs	2 x 0...10 V inputs	–	1	1	Screw (3.81/0.15)	TM221M16R	0.264 0.582
				–	1	1	Spring (3.81/0.15)	TM221M16RG	0.264 0.582
				1	1	–	Screw (3.81/0.15)	TM221ME16R	0.264 0.582
		8 source transistor outputs, inc. 2 high-speed outputs	2 x 0...10 V inputs	–	1	1	Screw (3.81/0.15)	TM221M16T	0.264 0.582
				–	1	1	Spring (3.81/0.15)	TM221M16TG	0.264 0.582
				1	1	–	Screw (3.81/0.15)	TM221ME16T	0.264 0.582
32 inputs/ outputs	16 sink/source 24 V $\bar{\square}$ inputs, inc. 4 high-speed inputs	16 source transistor outputs, inc. 2 high-speed outputs	2 x 0...10 V inputs	–	1	1	HE 10 connector	TM221M32TK	0.270 0.595
				1	1	–	HE 10 connector	TM221ME32TK	0.270 0.595
				1	1	–	HE 10 connector	TM221ME32TK	0.270 0.595

- (1) M221 Book controllers are supplied with:
- removable terminal blocks (screw or spring-type depending on controller model) for connecting the I/O
 - a removable screw terminal block for connecting the power supply
 - a button cell backup battery (BR2032)
 - a cable for connecting the analog inputs

(2) Each M221 Book logic controller has an embedded USB mini-B programming port.

Modicon M221 and M221 Book logic controllers

Options, separate parts



TMH2GDB



ZB5AZ905



A9A15151



DX1AP52



XBTZ9980



TMASD1



TMAHOL02

References

Remote graphic display unit, mounting accessories, cable

Designation	Description	Unit reference	Weight kg/lb
Remote graphic display unit	<input type="checkbox"/> For data display and modification (1) <input type="checkbox"/> Contains 1 bezel key ZB5AZ905	TMH2GDB	0.170 0.37
Tightening tool	For tightening the cover on Ø 22 mm unit	ZB5AZ905	0.016 0.04
Mounting plate for symmetrical rail (Sold in lots of 4)	For clipping onto 35 mm (1.378 in.) symmetrical rail (1 hole Ø 22 mm (0.87 in.))	A9A15151	0.040 0.09
Metal bracket for panel mounting, threaded (Sold in lots of 10)	1 hole Ø 22 mm (0.87 in.) Mounted using 2 screws, 7 mm (0.28 in.) diameter	DX1AP52	0.065 0.014
Connecting cables	Equipped with an RJ 45 connector at each end Length: 2.5 m (8.2 ft)	XBTZ9980	0.230 0.51
Used between TMH2GDB remote display unit and M221/M221 Book logic controller	Equipped with an RJ 45 connector at each end Length: 1 m (3.28 ft)	VW3A1104R10	0.050 0.110

Option

Industrial SD memory card	Application backup and program transfer Capacity: 256 MB	TMASD1	0.004 0.009
---------------------------	---	--------	----------------

Separate parts

Designation	Description	Unit reference	Weight kg/lb
Mounting kit (Sold in lots of 10)	For plate or panel mounting of M221 and M221 Book controllers	TMAM2	0.065 0.143

Replacement parts

Designation	Description	Reference	Weight kg/lb
Set of terminal blocks for connecting the power supply on M221 and M221 Book logic controllers	8 removable screw terminal blocks	TMAT2PSET	0.127 0.280
Set of terminal blocks for connecting the I/O on M221 controllers	Removable screw terminal connectors: 8 different connectors for equipping a TM221C●●●● logic controller (8 x I/O)	TMAT2CSET	0.127 0.280
Set of terminal blocks for connecting the I/O on M221 Book controllers	4 x 10-way and 4 x 11-way removable terminal blocks with screw terminals	TMAT2MSET	0.127 0.280
	4 x 10-way and 4 x 11-way removable terminal blocks with spring terminals	TMAT2MSETG	0.127 0.280
Set of battery holders	2 spare battery holders for M221 and M221 Book controllers	TMAHOL02	0.130 0.286
Backup battery	The battery supplied with each controller is not available as a spare part in the Schneider catalog. If a replacement part is needed, use a Panasonic battery type BR2032 only.		

(1) Compatible only with M221 and M221 Book logic controllers whose firmware is version V1.3 or later.

Modicon M221 and M221 Book logic controllers

Programming software, expansion modules, connection cables



EcoStruxure Machine Expert - Basic software

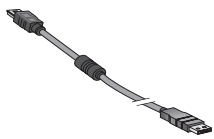

TCSXCNAMUM3P

References				
Programming software				
Description	For use with	Reference		
EcoStruxure Machine Expert - Basic	For Modicon M221 and M221 Book logic controllers	Only available as a download from our website www.schneider-electric.com		
Expansion modules				
Description	For use with	Reference		
Modicon TM3 expansion modules	For Modicon M221 and M221 Book logic controllers	Please consult our catalogue ref. DIA3ED2140109EN		
Connection cables				
Description	Use	Length	Reference	Weight kg/lb
Programming cordsets	From the PC USB port to the USB mini-B port on M221 and M221 Book controllers	3 m (0.98 ft)	TCSXCNAMUM3P (1)	0.065 / 0.143
		1.8 m (5.90 ft)	BMXXCAUSBH018	0.065 / 0.143
Cable for connecting the analog inputs embedded in M221 and M221 Book controllers	Equipped with 1 dedicated removable connector at one end and bare wires at the other end	1 m (3.28 ft)	TMACBL1	0.024 / 0.053

(1) Unshielded, non-grounded cable. Only for use on temporary connections. For permanent connections, use cable reference BMXXCAUSBH018.

A

A9A15151 20

Z

ZB5AZ905 20

B

BMXXCAUSBH018 21

D

DX1AP52 20

T

TCSXCNAMUM3P 21

TM221C16R 18

TM221C16T 18

TM221C16U 18

TM221C24R 18

TM221C24T 18

TM221C24U 18

TM221C40R 18

TM221C40T 18

TM221C40U 18

TM221CE16R 18

TM221CE16T 18

TM221CE16U 18

TM221CE24R 18

TM221CE24T 18

TM221CE24U 18

TM221CE40R 18

TM221CE40T 18

TM221CE40U 18

TM221M16R 19

TM221M16RG 19

TM221M16T 19

TM221M16TG 19

TM221M32TK 19

TM221ME16R 19

TM221ME16RG 19

TM221ME16T 19

TM221ME16TG 19

TM221ME32TK 19

TMACBL1 21

TMAHOL02 20

TMAM2 20

TMASD1 20

TMAT2CSET 20

TMAT2MSET 20

TMAT2MSETG 20

TMAT2PSET 20

TMC2AI2 18

TMC2AQ2C 18

TMC2AQ2V 18

TMC2CONV01 18

TMC2HOIS01 18

TMC2PACK01 18

TMC2SL1 18

TMC2TI2 18

TMH2GDB 20

V

VW3A1104R10 20

X

XBTZ9980 20

A trusted partner of Schneider Electric

Wildcat Electric Supply/CED

www.wildcatelectric.com

7136760600

adam.burd@wildcatelectric.com



www.schneider-electric.com/Machine control solutions

Schneider Electric Industries SAS

Head Office
35, rue Joseph Monier
F-92500 Rueil-Malmaison
France

The information provided in this documentation contains general descriptions and/or technical characteristics of the performance of the products contained herein. This documentation is not intended as a substitute for and is not to be used for determining suitability or reliability of these products for specific user applications. It is the duty of any such user or integrator to perform the appropriate and complete risk analysis, evaluation and testing of the products with respect to the relevant specific application or use thereof. Neither Schneider Electric nor any of its affiliates or subsidiaries shall be responsible or liable for misuse of the information contained herein.

Design: Schneider Electric
Photos: Schneider Electric